

PEAK INTERNATIONAL TRADE (TIANJIN) CO., LTD.

BID Proposal

(PART II/II)

Recipient: Ministry of Labour and Social Policy of the Republic of North Macedonia

Subject: North Macedonia Emergency Covid-19 Response Project - Procurement of the modular prefabricated containers

RFB Number: MK/ERCP # 1.1.7

Date: Oct 26, 2020

TABLE OF CONTENT

1. SECTION 1 – BIDDING SUBMITTAL (For details see the separator page)
2. SECTION 2 – TECHNICAL PROPOSAL IN DETAILS
 - DRAWINGS
 - STANDARD COMPARATION
 - DESIGN CALCULATION (reference pages attached)
 - PRODUCT CATALOGUE FOR FLAT PACK HOUSE
 - REMARKS FOR THE TENDER
3. SECTION 3 – OTHER SUBMITTALS
 - LIST OF MAIN MATERIALS
 - CERTIFICATES AND QUALITIFICAITON
 - INSTALLATION INSTRUCTION
 - CONSTRUCTION PLAN
4. SECTION 4 - ABOUT MANUFACTURER AND DESIGN INSTITUTE
5. SECTION 5 - ABOUT PEAK INTERNATIONAL

Contact Person: Mr. Frank Wang – Project Manager

PEAK INTERNATIONAL TRADE (TIANJIN) CO., LTD.
38 DALI ROAD, HEPING DISTRICT, TIANJIN, CHINA
TEL: 86-22-2319.1608
FAX: 86-22-89886660
E-MAIL: export@peakglobe.com



UNGM Registered Supplier No.: 113512
United Nations Vender ID: 25290



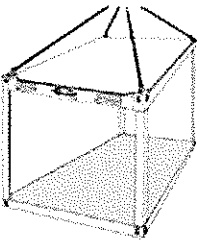
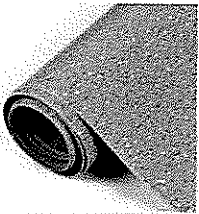
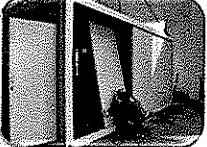
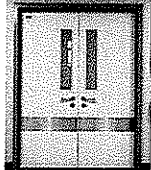
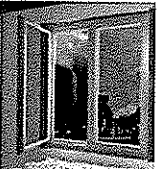

SECTION 3 – OTHER SUBMITTALS

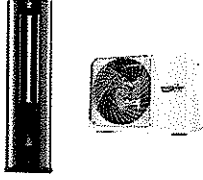
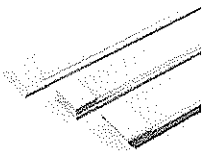
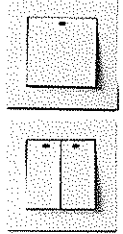
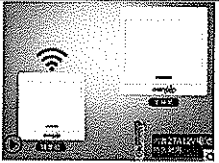
- LIST OF MAIN MATERIALS
- CERTIFICATES AND QUALITIFICAITON
- INSTALLATION INSTRUCTION
- CONSTRUCTION PLAN

List of main materials

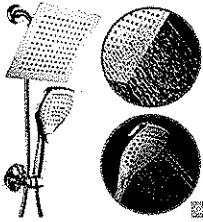
No.	Item	Picture	Description	Standard
1	Constructi on		Structural steel dimensioning according to static calculation; Anticorrosive iron steel, epoxy coated with 4 layers of paint, constructive S235JR or "equivalent"; Steel construction depth, minimum 3mm;	
2	Ceiling		Ecological wall panels (PUR) 75mm, which save heat, sound isolation included, covered with exterior and interior facade. Interior depth of plasticized stake, minimum 0,4mm exterior minimum 0,4mm, polyurethane weight, minimum 42kg/m ³ , thermal conductivity, maximum 0,43 U(W/m ² K) RAL 9002/9002.	
3	Floor		-Cement table 10mm with amortization, connecting the steel beam -Thermal isolation 10 cm, extruded polystyrene; -Steel beam dimensions: structural steel dimensioning according to static calculation. -Cement table 20mm -OSB boards; -Homogeneous Vinyl PVC Flooring, minimum 2mm, suitable for wheelchairs, fire resistant, electrostatic, and antibacterial, chemicals and sliding conformed to: EN13501, ISO26987-EN423, ISO846. Glued and welded with electrodes, cove former profile, radius 25mm, height 10 cm, depth 2mm.	
4	Wall panel		Ecological wall panels (PUR) 75mm, which save heat, sound isolation included, covered with exterior and interior facade. Interior depth of plasticized stake, minimum 0,4mm, exterior minimum 0,4mm, polyurethane weight, minimum 42 kg/m ³ , thermal conductivity, maximum:0,43 U(W/m ² K) RAL 9002/9002;	
5	Doors		PVC – double-leaf door – 180/210cm & 120/210cm & 105/210cm with 50% filled panel and 50% mating glass 4x16x4 set with: shackle, door knob, lock and floor border and rooms numbering, dimensions 12/24 cm. The number of elements and their positioning should be in accordance with the drawings attached herein.	
6	Window		PVC single-leaf double hung window, with insulated glass, dimensions 80/120cm & 80/100cm and parapet at height of 90cm, interior venetian blinds and mating 50% of glass surface with foil, exterior mosquito net. The number of elements and their positioning should be in accordance with the drawings attached herein. PVC single-leaf double hung window, with insulated glass, dimensions 60/60cm and parapet at height of 150cm. The number of elements and their positioning should be in	

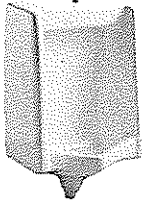
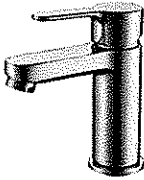
			accordance with the drawings attached herein.	
7	Air conditioning		3,5 KW, Electrical installation: Cooling/Heating: Cooling/Heating Specification: 34KG Power Source: Electrical Power Type: DC Wi-Fi Control, Comfortable Sleep, Whispering-Air, Self-Clean, Balanced Temperature, Golden Airflow, Golden Air Quality	CE, CCC
8	LED light		LED lights x 18w Housing Material: Acrylic, Aluminum, PMMA Emitting Color: Cool/Warm/White/RGB Appearance: Square Type: Ceiling	CE, CCC
9	power outlet		6 single-phase upgraded power outlet; 1 single-phase upgraded power outlet- air conditioner Protection: Durable, Explosion-Proof, Waterproof Feature: Flat Wiring: Null Line and Live Line Application: Home Appliance, Electronics, Lighting, Industrial, Apartment/Villa, Hotel, Commercial, Home Number of Switch: Single Control Switch Usage: Change-over Switch	CE, CCC
10	Remote control switch		Remote control switch Wireless remote control intelligent light pane A master switch controls multiple separate shutoffs	CE, CCC
11	Squatting Pan		Material: Porcelain Surface Treatment: Glazed Shape: Rectangular Sink Style: Single Bowl Notch: Single Sink	CE, UPC
12	Toilet		Material: Ceramic Structure: One Piece Drainage: Siphonic Flushing Control: Hand Press Type Mounting Type: Standing Floor	CE, UPC

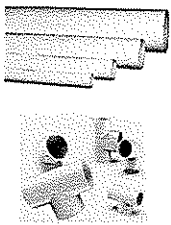
13	Shower		<p>Number of Handles: Single Handle</p> <p>Finish: Chrome</p> <p>Color: Chrome</p> <p>Material: Chrome Plated Premium ABS</p> <p>Pattern: Contemporary Bathroom Access</p> <p>Installation Method: Wall-Mounted</p>	CE, UPC
14	Wash Basin		<p>Self-Cleaning Glaze Chinese Round Bathroom Ceramic</p> <p>Pedestal Wash Basin</p> <p>Material: Ceramic</p> <p>Surface Treatment: Brushed</p> <p>Installation Type: Above Counter</p> <p>Shape: Square</p> <p>Notch: Single Basin</p> <p>Sink Style: Single Bowl</p>	CE, UPC
15	Wall-hung Urinal		<p>Material: Ceramic</p> <p>Drainage: Washdown</p> <p>Flushing Control Method: Hand Press Type</p> <p>Mounting Type: Standing Floor</p> <p>Sensor: Without Sensor</p> <p>Water Consumption: Ordinary Type</p>	CE, UPC
16	Basin faucet		<p>Material: Brass</p> <p>Structure: Single Hole</p> <p>Surface Treatment: Chrome Plating</p> <p>Function: Metered Faucet</p> <p>Installation: Deck Mounted</p>	CE, UPC
17	Stainless steel braided hose		<p>Red Blue mark is clear in heat & cold water</p>	CE, UPC
18	PVC Pipes & fittings		<p>Material: PVC</p> <p>Surface Treatment: Galvanized Sheet</p> <p>used for the conveyance of drinking water, waste water</p>	CE, DVGW Certificate

CELAB®

Via Malra snc
04100 Latina
Italy
celab@celab.com

celab ✓

CERTIFICATE

Certificate Number UCN : 802825642929
Job : J30727
Date of issue : 2020-04-21
Certificate valid up to : 2024-04-20

Brand Name : See Label
Type : Metal surface insulation sandwich board
Model N : 50-980, 75-980, 100-980, 50-1180, 75-1180, 100-1180

Manufacturer : Suzhou Haorui Purification Technology Co., Ltd.
Address : No. 1178, Jinshe Road, Fenhu Town, Wujiang District,
Suzhou China

Conclusion :

After inspection of the technical documentation issued by the customer, and in his request, we express the following opinion.

This opinion is only valid for the directive, the equipment and configuration described, in conjunction with the test data detailed above and with compliance with all applicable legal requirement for the product.

The following manufacturer documents were inspected:

Directives indicated in the Declaration of Conformity: (EU)305/2011 Construction products (CPR)	
Standard used in the product: EN 14509:2013	
Presence of Declaration of conformity	✓ OK
Presence of test report using standards as indicated in the declaration of conformity Test report reference : B-S200328446	✓ OK
Presence of CE symbol in the product label	✓ OK
Presence of instruction manual	✓ OK
Use of valid Harmonized standard in the declaration of conformity	✓ OK
Presence of product description in the technical construction file	✓ OK

Copyright of this Certificate is owned by CELAB® Italy and may not be reproduced other than in full and with the prior approval of the General Manager. Use of this certificate is subjected to Celab regulation available on Celab web site.

Check the authenticity of this certificate and related information before use in the web site www.celab.com introducing the UCN number in the 'Check document authenticity' area. You will see copy of this certificate and regulation on certificate use. This document is released only for scope allowed by laws- Do not use this document without full understanding of regulation.

Massimiliano Bertoldi
General Manager - CELAB
www.celab.com

Massimiliano Bertoldi

www.celab.com

LESSO

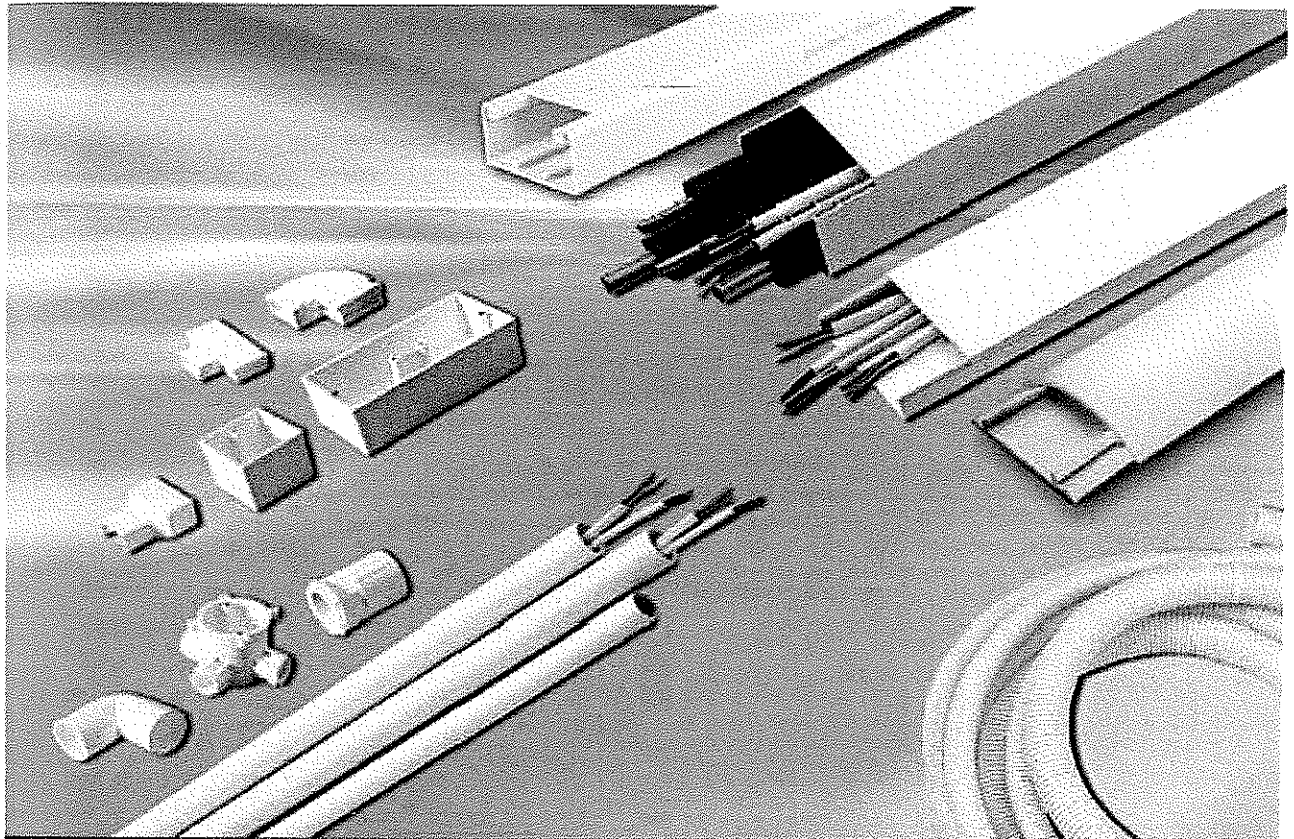

PVC Conduit, Trunking and Fittings
PVC Round Type Wiring Duct Series



www.lesso.com

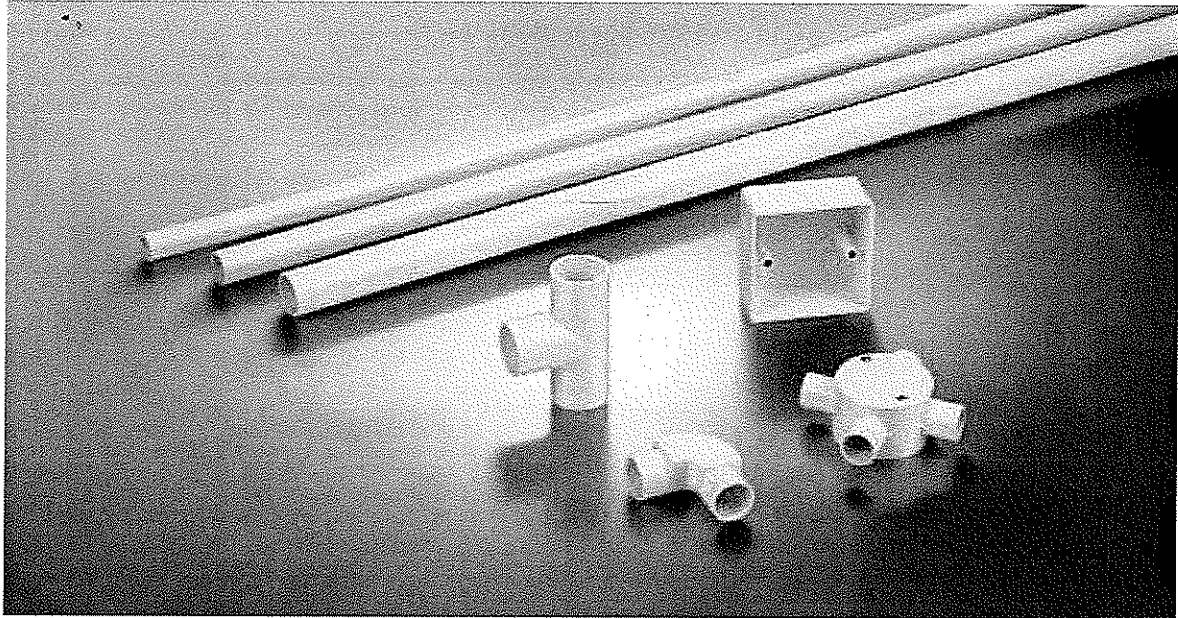

Standard: IEC 614, IEC 61386-1, IEC 61386-21, AS/NZS 2053.2

Colors: white and other colors upon request

Length: according to customer's requests

■ Advantages

◦ **Excellent non-conductive performance:**

The conduit has excellent non-conductive performance, high current breakdown voltage resistance.

There's no electrical danger by using Liansu UPVC conduit, because it can resist 25 thousand volt without breakage.

◦ **Good compressure resistance:**

The conduit can be layed in the concrete with good compressure resistance.

◦ **Good fire resistance:**

The conduit has good combustion resistance.

◦ **Moist resistance, corrosion resistance:**

The conduit can resist moist, unaffected by electrical reactions caused by acids, bases, and oils that cause corrosion in metals.

◦ **Anti-insect:**

The conduit can avoid be bitten by insects.

◦ **Easy to bend:**

Insect one spring into the pipe, then the pipe can be easily bent without heating.

◦ **Easy installation:**

Use Liansu cement to connect the pipe and all kinds of accessories.

■ Applications

- Protect and manage indoor electrical wiring.

CE Certification for PVC Conduit and Fittings Comply with EN 61386-1, EN 61386-21, EN 61386-23, IEC 61084-1, IEC 61084-2-1.

Certificate - Сертификат - 證明書 - Certificat - 증명서 - شهادة

Certificate of Compliance



No. 08170531.GLTUC88

Test Reports no. SCC117)-50005A-25-10-LVD

Certificate's Holder:

Guangdong Liansu Technology Industrial Co., Ltd.
Liansu Industrial Estate, Longzang Town, Shunde Zone, Foshan City, Guangdong Province, China

Certification ECM Mark:



Product:

PVC Conduit and Fittings, PVC Trunking and Fittings

Model(s):

PVC Conduit and Fittings	DN6-75mm
PVC Trunking and Fittings	DN10-200mm

Verification to:

Standard:

EN 61386-1:2008, EN 61386-21:2004+A11:2010, EN 61386-23:2004+A11:2010, IEC 61084-1:2017, IEC 61084-2-1:2017

related to CE Directive(s):
2014/35/EU (Low Voltage)

Remark: The product(s) has been verified on a voluntary basis. The product(s) satisfies the requirements of the Certification Mark of ECM. In reference to the above listed Standard(s), the above Compliance Mark can be affixed on the product(s) accordingly to the ECM regulation about its release and its use. The regulation can be found at www.entecerma.it. This Certificate of Compliance can be checked for validity at www.entecerma.it.

This verification doesn't imply assessment of the production of the product(s).

Additional information, clarification about the CE Marking:



We attest that a TCF for the CE Marking process is in place. Whereas the Manufacturer is Responsible to start the CE Marking Certification Procedure and to perform all the necessary activities, as required by the Directive before placing the CE Mark on the product(s).

Date of issue 31 May 2017

Expiry date 30 May 2022

Chief Manager
Marta Marini

Deputy Manager
Amanda Payne

Ente Certificazione Macchine Srl

Via Ca' Beola, 243 - Loc. Castello di Serravalle - 40053 Vasomoggia (BO) - ITALY
☎ +39 051 4705141 ☎ +39 051 4705156 ✉ info@entecerma.it 🌐 www.entecerma.it

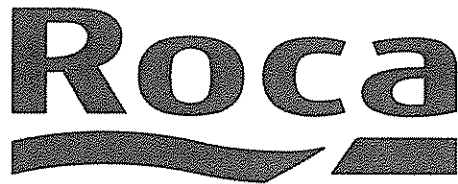

DECLARATION OF PERFORMANCE

DoP No. 14688

1. Unique identification code of the product-type:
For product number please see attached list

2. Intended use/es:
Personal hygiene (PH)

3. Manufacturer:

**ROCA Sanitario, S.A., Diagonal, 513 08029 Barcelona (España)
Tel: +34 93 635 16 00 / website: www.roca.net**

4. Authorised representative:
Not applicable

5. System/s of AVCP:
System 4

6. Harmonised standard:
EN 14688:2015

7. Declared performance/s:

Essential Characteristics	Performance
LR - Load resistance	Pass
CA - Cleanability	Pass
OF - Flow rate of overflow	Pass
DA - Durability	Pass

8. Appropriate Technical Documentation and/or Specific Technical Documentation:
Not applicable

The performance of the product identified above is in conformity with the set of declared performance/s. This declaration of performance is issued, in accordance with Regulation (EU) No 305/2011, under the sole responsibility of the manufacturer identified above.

Signed for and on behalf of the manufacturer by:
Ferran Figuerola, Manufacturing Director

At **Gavà (Barcelona)** on **09.06.2017**

<u>Range</u>	<u>Product Code</u>	<u>Description</u>	<u>Designation Code</u>
ACCESS	327230/ 1/ 2	Wall-Hung Basin	EN 14688 - CL 00
ADELE	325191/ 2/ 5/ 6	Wall-Hung Basin	EN 14688 - CL 25
AGADIR	327828/ 9	Vanity Basin	EN 14688 - CL 25
AIRE	3270F1/ 2/ 3/ 4	Wall-Hung Basin	EN 14688 - CL 25
ALOA	327865	Over-Countertop Basin	EN 14688 - CL 20
AMBERES	327270 & 893030001	Basin	EN 14688 - CL 00
AMERICA	327495	Over-Countertop Basin	EN 14688 - CL 20
AMERICA	327490/ 1	Wall-Hung Basin	EN 14688 - CL 20
ARMANI	32.760	Over-Countertop Basin	EN 14688 - CL 15
ARMANI	32.761	Over-Countertop Basin	EN 14688 - CL 15
ARMANI	327762	Basin	EN 14688 - CL 15
ARMANI GUAPO	327831/ 2	Under or Over-Countertop Basin	EN 14688 - CL 00
ARMANI-BAIA	3270C0/ C1/ C2/ C3/C6/ C7/ C8	Over-Countertop Basin	EN 14688 - CL 25
ARMANI-BAIA	3270CE	Basin	EN 14688 - CL 15
ART	327220/ 1	Over-Countertop Basin	EN 14688 - CL 00
ATIS	32W750	Wall-Hung Basin	EN 14688 - CL 25
ATLAS	3270M2/ 3/ 6/ 7/ 8/ 9	Basin	EN 14688 - CL 20
ATLAS UNIK	3270M0/ 1/ A/ B/ C/ E	Basin	EN 14688 - CL 25
BARCELONA	327360/ 1/ 2	Wall-Hung Basin	EN 14688 - CL 25
BERNA	327871	Under-Countertop Basin	EN 14688 - CL 20
BEYOND	3270B0/ 1/ 6/ 7/ 8/ 9/ A/ B/ C	Basin	EN 14688 - CL 00
BEYOND	AW2.....	Basin	EN 14688 - CL 00
BOL	327876/ A	Over-Countertop Basin	EN 14688 - CL 20
CALA	327424/ 5/ 8/ 9	Wall-Hung Basin	EN 14688 - CL 20
CARMEN	3270A0/ 1/ 5	Wall-Hung Basin	EN 14688 - CL 20
CASERTA	3270J0/ 1/ 2	Wall-Hung Basin	EN 14688 - CL 25
CASERTA	3270J3/ 4	Wall-Hung Basin	EN 14688 - CL 20
CIVIC	327920	Wall-Hung Basin	EN 14688 - CL 00
COM	327224	Over-Countertop Basin	EN 14688 - CL 00
CORAL	327898	Over-Countertop Basin	EN 14688 - CL 20
DAMA	327780/ 1/ 2/ 3/ 4/ 5/ 6/ 7/ 8/ 9	Wall-Hung Basin	EN 14688 - CL 25
DAMA	32778A/ B/ C	Wall-Hung Basin	EN 14688 - CL 25
DAMA	32778S	Semi-recessed Basin	EN 14688 - CL 25
DAMA RETRO	32.325	Wall-Hung Wash-stand	EN 14688 - CL 15
DAMA RETRO	325324	Over-Countertop Basin	EN 14688 - CL 20
DAMA RETRO	32.321/ 2/ 3	Wall-Hung Basin	EN 14688 - CL 20
DAMA RETRO	32.326/ 8/ 9	Semi-recessed Basin	EN 14688 - CL 20
DAMA SENSO	325514	Basin	EN 14688 - CL 20
DAMA SENSO	327516	Semi-recessed Basin	EN 14688 - CL 20
DAMA SENSO	32.510/ 1/ 2/ 3/ 7	Wall-Hung Basin	EN 14688 - CL 20
DAMA SENSO	327515/ E	Over-Countertop Basin	EN 14688 - CL 20
DEBBA	32.993/ 4/ 5/ 6/ 7/ 8/ 9	Basin	EN 14688 - CL 25
DEBBA	32799H/ J	Vanity Basin	EN 14688 - CL 20
DEBBA	32799M	Basin	EN 14688 - CL 25
DEBBA	32799S	Semi-recessed Basin	EN 14688 - CL 25
DIVERTA	327110/ 7	Wall-Hung or Over-Countertop Basin	EN 14688 - CL 20
DIVERTA	327111/ 8	Wall-Hung or Over-Countertop Basin	EN 14688 - CL 20
DIVERTA	327112/ 9	Wall-Hung or Over-Countertop Basin	EN 14688 - CL 20
DIVERTA	327114/ A	Under-Countertop Basin	EN 14688 - CL 25
DIVERTA	327116/ B	Over-Countertop Basin	EN 14688 - CL 20
DIVERTA	32711G	Over-Countertop Basin	EN 14688 - CL 20
DIVERTA	32711S	Semi-recessed Basin	EN 14688 - CL 20
DS COMPACT	327514	Wall-Hung Wash-stand	EN 14688 - CL 15
DS COMPACT	324518/ 9/ F/ G	Wall-Hung Basin	EN 14688 - CL 20
DS SQUARE	32751A/ B/ C/ H/ J/ K	Wall-Hung Basin	EN 14688 - CL 20
DS SQUARE	32751D/ P	Wall-Hung Wash-stand	EN 14688 - CL 15
DS SQUARE	32751L/ M/ N/ R/ T	Wall-Hung Basin	EN 14688 - CL 25
DS SQUARE	35751S/ Y	Semi-recessed Basin	EN 14688 - CL 25
ELEMENT	327571	Wall-Hung Basin	EN 14688 - CL 20
ELEMENT	327572	Over-Countertop Basin	EN 14688 - CL 25
ELEMENT	327576	Wall-Hung or Over-Countertop Basin	EN 14688 - CL 25

<u>Range</u>	<u>Product Code</u>	<u>Description</u>	<u>Designation Code</u>
ELEMENT	327570/ 4	Wall-Hung Basin	EN 14688 - CL 20
ELIPTIC	327426/ 7	Vanity Basin	EN 14688 - CL 00
EOS	32P513	Wall-Hung Basin	EN 14688 - CL 20
ESTUDIO	325200	Wall-Hung Basin	EN 14688 - CL 20
ESTUDIO	327202	Wall-Hung Basin	EN 14688 - CL 25
FEDRA	3270J5	Basin	EN 14688 - CL 20
FONDA	3270J6	Basin	EN 14688 - CL 25
FONTANA	327877	Wall-Hung or Over-Countertop Basin	EN 14688 - CL 20
FORO	327880	Over-Countertop Basin	EN 14688 - CL 20
FORO	327872/ B	Over-Countertop Basin	EN 14688 - CL 20
FORO	327884/ 6	Under-Countertop Basin	EN 14688 - CL 20
FORO	32788F	Under-Countertop Basin	EN 14688 - CL 20
FORUM	32788A	Wall-Hung Basin	EN 14688 - CL 20
FRONTALIS	327580	Wall-Hung Basin	EN 14688 - CL 20
FRONTALIS	327581	Wall-Hung Basin	EN 14688 - CL 20
FUEGO	32.22E	Over-Countertop Basin	EN 14688 - CL 00
GIRALDA	32.461/ C	Wall-Hung Basin	EN 14688 - CL 20
GIRALDA	32.462/ D	Wall-Hung Basin	EN 14688 - CL 20
GIRALDA	32.463/ E	Wall-Hung Basin	EN 14688 - CL 20
GIRALDA	327465/ H	Over-Countertop Basin	EN 14688 - CL 20
GIRALDA	327467/ F	Semi-recessed Basin	EN 14688 - CL 20
GIRALDA	327468/ G	Wall-Hung Basin	EN 14688 - CL 20
GRAND BERNA	327899	Under-Countertop Basin	EN 14688 - CL 20
HALL	327621	Wall-Hung or Over-Countertop Basin	EN 14688 - CL 20
HALL	32.883/ 4	Wall-Hung or Over-Countertop Wash-stand	EN 14688 - CL 25
HALL	327620/ 5	Wall-Hung or Over-Countertop Basin	EN 14688 - CL 20
HALL	327622/ 6	Wall-Hung Wash-stand	EN 14688 - CL 15
HALL	327623/ 7	Wall-Hung Wash-stand	EN 14688 - CL 15
HALL	327624/ 8	Wall-Hung Wash-stand	EN 14688 - CL 15
HALL	32762G	Over-Countertop Basin	EN 14688 - CL 25
HALL	32762K	Wall-Hung Basin	EN 14688 - CL 25
HALL	327881/ C	Wall-Hung or Over-Countertop Basin	EN 14688 - CL 20
HALL	327882/ 7	Over-Countertop Basin	EN 14688 - CL 00
HALL	32788H	Basin	EN 14688 CL 00
HAPPENING	327560	Wall-Hung or Over-Countertop Basin	EN 14688 - CL 20
HAPPENING	327564	Wall-Hung or Over-Countertop Basin	EN 14688 - CL 20
HAPPENING	327561/ 6	Wall-Hung or Over-Countertop Basin	EN 14688 - CL 20
HAPPENING	327562/ 7	Wall-Hung or Over-Countertop Basin	EN 14688 - CL 20
HAPPENING	327563/ 8	Wall-Hung or Over-Countertop Basin	EN 14688 - CL 20
HAPPENING	327565/ 9	Over-Countertop Basin	EN 14688 - CL 20
HOTEL'S	32.930/ 1/ 2/ 3/ 4/ 5	Wall-Hung Basin	EN 14688 - CL 25
IBIS	32.841	Wall-Hung Wash-stand	EN 14688 - CL 15
IBIS	328842	Wall-Hung Wash-stand	EN 14688 - CL 15
INSPIRA	327504	Basin	EN 14688 - CL 00
INSPIRA	327527	Basin	EN 14688 - CL 00
INSPIRA	327534	Basin	EN 14688 - CL 00
INSPIRA	324535/ 6	Under-Countertop Basin	EN 14688 - CL 00
INSPIRA	327500/ 2/ R	Over-Countertop Basin	EN 14688 - CL 00
INSPIRA	327520/ 3/ R	Over-Countertop Basin	EN 14688 - CL 00
INSPIRA	32752A/ B/ C	Vanity Basin	EN 14688 - CL 25
INSPIRA	327530/ 3/ R	Over-Countertop Basin	EN 14688 - CL 00
INSPIRA	32753S	Semi-recessed Basin	EN 14688 - CL 25
JAVA	32763/ 4/ C	Over-Countertop Basin	EN 14688 - CL 20
KALAHARI	327874/ 6/ 7/ 8/ B/ C/ D/ E	Wall-Hung Basin	EN 14688 - CL 00
KALAHARI	327894/ A	Over-Countertop Basin	EN 14688 - CL 00
KHROMA	327650	Wall-Hung or Vanity Basin	EN 14688 - CL 20
KHROMA	327651	Wall-Hung or Vanity Basin	EN 14688 - CL 20
KHROMA	327652	Wall-Hung or Vanity Basin	EN 14688 - CL 20
KHROMA	327653	Over-Countertop Basin	EN 14688 - CL 25
KHROMA	327654	Over-Countertop Basin	EN 14688 - CL 25
KHROMA	327655	Over-Countertop Basin	EN 14688 - CL 20
LONG ISLAND	327113/ C	Wall-Hung or Over-Countertop Basin	EN 14688 - CL 20
MERIDIAN	32.244	Wall-Hung Basin	EN 14688 - CL 25
MERIDIAN	32.240/ 1/ 2/ 3	Wall-Hung Basin	EN 14688 - CL 20
MERIDIAN	32.245/ T/ X	Wall-Hung Basin	EN 14688 - CL 20
MERIDIAN	327248/ C	Wall-Hung Basin	EN 14688 - CL 15
MERIDIAN	327249/ H/ L/ R/ Y/ Z	Wall-Hung Basin	EN 14688 - CL 20
MERIDIAN	32724A/ B/ D	Wall-Hung Basin	EN 14688 - CL 25

<u>Range</u>	<u>Product Code</u>	<u>Description</u>	<u>Designation Code</u>
MERIDIAN	32724E	Over-Countertop Basin	EN 14688 - CL 25
MERIDIAN	32724M	Vanity Basin	EN 14688 - CL 25
MERIDIAN	32724S	Semi-recessed Basin	EN 14688 - CL 25
MINI	327MS1	Vanity Basin	EN 14688 - CL 15
MITOS	327BK3	Wall-Hung Basin	EN 14688 - CL 20
MITOS	327BK4	Wall-Hung Basin	EN 14688 - CL 20
MODO	AW1.....	Basin	EN 14688 - CL 15
MOHAVE	327879/ F	Wall-Hung Basin	EN 14688 - CL 00
MOHAVE	327889/ B	Wall-Hung Basin	EN 14688 - CL 00
NEO-SELENE	322307	Under or Over-Countertop Basin	EN 14688 - CL 25
NEXO	327643	Wall-Hung Wash-stand	EN 14688 - CL 15
NEXO	327644	Vanity Basin	EN 14688 - CL 20
NEXO	327645	Wall-Hung Wash-stand	EN 14688 - CL 20
NEXO	327646	Wall-Hung Basin	EN 14688 - CL 25
NEXO	327648	Basin	EN 14688 - CL 20
NEXO	327640/ 1/ 2/ 9	Wall-Hung Basin	EN 14688 - CL 20
NEXO	32764A/ B/ C/ D/ E/ F	Wall-Hung Basin	EN 14688 - CL 00
NEXO	32764H/ J/ K/ M	Over-Countertop Basin	EN 14688 - CL 25
NEXO	32764L	Over-Countertop Basin	EN 14688 - CL 00
NEXO	32764N	Over-Countertop Basin	EN 14688 - CL 00
NORA	327BK5	Wall-Hung Basin	EN 14688 - CL 20
NORA	327BK6	Wall-Hung Basin	EN 14688 - CL 20
ORBITA	327222	Over-Countertop Basin	EN 14688 - CL 00
ORBITA	327223/ G	Over-Countertop Basin	EN 14688 - CL 00
OVAL	327824	Vanity Basin	EN 14688 - CL 25
OVAL	327825	Vanity Basin	EN 14688 - CL 25
OVAL	327826	Vanity Basin	EN 14688 - CL 25
OVAL	327827	Vanity Basin	EN 14688 - CL 25
POST	32722R	Over-Countertop Basin	EN 14688 - CL 00
PRISMA	327540/ 1/ 2/ 3/ 4/ 5/ 6/ 9	Wall-Hung or Vanity Basin	EN 14688 - CL 25
PRISMA	32754B/ C/ D/ E	Vanity Basin	EN 14688 - CL 25
RECORD	327150	Wall-Hung or Over-Countertop Basin	EN 14688 - CL 20
RECORD	327151	Wall-Hung or Over-Countertop Basin	EN 14688 - CL 20
RECORD	327152	Wall-Hung or Over-Countertop Basin	EN 14688 - CL 20
RECORD	327153	Wall-Hung or Over-Countertop Basin	EN 14688 - CL 20
RODEO	327866	Over-Countertop Basin	EN 14688 - CL 20
SIZA	327341	Wall-Hung Basin	EN 14688 - CL 20
SIZA	327342	Wall-Hung Basin	EN 14688 - CL 20
SOFIA	327720	Over-Countertop Basin	EN 14688 - CL 00
SPUN	327140	Wall-Hung Wash-stand	EN 14688 - CL 15
STRATUM	327630/ 5	Wall-Hung or Vanity Basin	EN 14688 - CL 20
STRATUM	327631/ 6	Wall-Hung or Vanity Basin	EN 14688 - CL 20
STRATUM	327632/ 7	Wall-Hung or Vanity Basin	EN 14688 - CL 20
STRATUM	32763A	Wall-Hung or Vanity Basin	EN 14688 - CL 00
STRATUM	32763B	Wall-Hung or Vanity Basin	EN 14688 - CL 00
STRATUM	32763C	Wall-Hung or Vanity Basin	EN 14688 - CL 00
SUIT	325000/ 1/ 2/ 3/ 4/ 6/ 7	Vanity Basin	EN 14688 - CL 25
TERRA	32722D	Over-Countertop Basin	EN 14688 - CL 00
TERRA	32722T	Over-Countertop Basin	EN 14688 - CL 20
THE GAP	327470/ 1/ 2/ T	Vanity Basin	EN 14688 - CL 25
THE GAP	327473/ 4/ 5/ 6/ 7/ 8/ 9/ A/ B/ C	Wall-Hung Basin	EN 14688 - CL 25
THE GAP	32747D/ E/ F/ G/ H/ J/ K/ L/ R	Wall-Hung Basin	EN 14688 - CL 25
THE GAP	32747N/ S	Semi-recessed Basin	EN 14688 - CL 25
THE GAP	32747P	Semi-recessed Basin	EN 14688 - CL 20
THE GAP	32747V/ W/ Y/ Z	Basin	EN 14688 - CL 20
TIBER	327260	Wall-Hung Basin	EN 14688 - CL 25
TIBER	327261	Wall-Hung Basin	EN 14688 - CL 25
TIBER	327263	Wall-Hung Basin	EN 14688 - CL 25
TIPO	32750	Wall-Hung Basin	EN 14688 - CL 25
URBAN	32765G/ H/ L/ P/ R/ S/ U	Over-Countertop Basin	EN 14688 - CL 25
URBI	327225	Over-Countertop Basin	EN 14688 - CL 20
URBI	327226/ A	Over-Countertop Basin	EN 14688 - CL 00
URBI	327227/ 8/ 9/ B/ C	Over-Countertop Basin	EN 14688 - CL 20
VELA	32W512	Wall-Hung Basin	EN 14688 - CL 20
VERANDA	327446	Over-Countertop Basin	EN 14688 - CL 20
VERANDA	327447	Over-Countertop Basin	EN 14688 - CL 20
VERANDA	327442/ B	Wall-Hung Basin	EN 14688 - CL 20
VERANDA	327443/ C	Wall-Hung or Over-Countertop Basin	EN 14688 - CL 20
VERANDA	327444/ A	Wall-Hung or Over-Countertop Basin	EN 14688 - CL 00

<u>Range</u>	<u>Product Code</u>	<u>Description</u>	<u>Designation Code</u>
VICTORIA	32.392/ L	Wall-Hung Basin	EN 14688 - CL 20
VICTORIA - LAURA	325316	Wall-Hung Wash-stand	EN 14688 - CL 15
VICTORIA - LAURA	326390	Wall-Hung Basin	EN 14688 - CL 20
VICTORIA - LAURA	325314/ 5	Wall-Hung Wash-stand	EN 14688 - CL 15
VICTORIA PLUS	32799F/ G	Basin	EN 14688 - CL 20
VICTORIA PLUS	32799H	Basin	EN 14688 - CL 20
VICTORIA-N	32.99A/ B/ C/ D/ E/ K	Vanity Basin	EN 14688 - CL 20
VICTORIA-N - LAURA	32.391	Wall-Hung Basin	EN 14688 - CL 20
VICTORIA-N - LAURA	32.393/ 6/ M	Wall-Hung Basin	EN 14688 - CL 20
VICTORIA-N - LAURA	32.394/ D/ 8	Wall-Hung Basin	EN 14688 - CL 20
VICTORIA-N - LAURA	32639H	Wall-Hung Basin	EN 14688 - CL 00
VICTORIA-N - LAURA	32639J	Wall-Hung Basin	EN 14688 - CL 00
VICTORIA-N - LAURA	32639K	Wall-Hung Basin	EN 14688 - CL 00
VICTORIA-N - LAURA	32739E/ F	Semi-recessed Basin	EN 14688 - CL 20
ZOOM-APOLO PLUS	325172	Wall-Hung Basin	EN 14688 - CL 20
ZOOM-APOLO PLUS	325173	Wall-Hung Basin	EN 14688 - CL 20
ZOOM-LAURA	326311	Wall-Hung Basin	EN 14688 - CL 20
ZOOM-POLO	32529H	Wall-Hung Wash-stand	EN 14688 - CL 15
ZOOM-POLO	32829D	Wall-Hung Basin	EN 14688 - CL 20
ZOOM-POLO-VPO	32.29A/ B/ C	Wall-Hung Basin	EN 14688 - CL 20

Philips Lighting



EU Declaration of Conformity

We, Philips Lighting

I.B.R.S./C.C.R.I. /Numéro 10461

5600 VB Eindhoven, The Netherlands

Internal Ref. Nr.: 082

Year in which CE Mark was first affixed: 2017

Page: 1/2

Declare under our responsibility for the products:

Product Range:	NAME: GreenSpace G5 DESCRIPTION: DN390B, 391B,392B,393B series
Product Code:	See Annex A

The designated products are in conformity with the essential requirements of the following European Directives and harmonized standards:

Low Voltage Directive (LVD), 2014/35/EU

- EN 60598-1:2015
- EN 60598-2-2:2012
- EN62493:2015
- EN62471:2008
- IEC/TR 62778:2014

Electromagnetic compatibility Directive (EMC), 2014/30/EU

- EN 55015: 2013 / A1: 2015
- EN 61547: 2009
- EN 61000-3-2: 2014
- EN 61000-3-3: 2013

EcoDesign requirements for energy-related products Directive (ErP), 2009/125/EC and applicable Implementing Measures

- Regulation 1194/2012

Restriction of the use of certain Hazardous Substances in electrical and electronic equipment Directive (RoHS), 2011/65/EU

- EN 50581:2012

and are produced under a quality scheme at least in conformity with ISO 9001 or CENELEC permanent documents.

This declaration of conformity is issued under the sole responsibility of the manufacturer.

6 December 2017

Sherry Zhu

Quality Manager

Business Professional Greater China

Philips Lighting



EU Declaration of Conformity

Internal Ref. Nr.: 082

Year in which CE Mark was first affixed: 2017

Page: 2/2

Annex A: product codes:

12NC	Product Description	12NC	Product Description
911401578041	DN390B LED6/830 PSU D100 ALU GM	911401585641	DN392B LED16/830 PSD D150 ALU GM
911401580741	DN390B LED6/830 PSU D100 ALU WP GM	911401585441	DN392B LED16/830 PSD D150 WH GM
911401582841	DN390B LED6/830 PSU D100 WH CAU	911401584841	DN392B LED16/830 PSD D200 ALU CAU
911401577741	DN390B LED6/830 PSU D100 WH GM	911401582241	DN392B LED16/830 PSD D200 ALU GM
911401583641	DN390B LED6/830 PSU D100 WH WP CAU	911401584641	DN392B LED16/830 PSD D200 WH CAU
911401578141	DN390B LED6/840 PSU D100 ALU GM	911401582041	DN392B LED16/830 PSD D200 WH GM
911401580841	DN390B LED6/840 PSU D100 ALU WP GM	911401579241	DN392B LED16/830 PSU D150 ALU GM
911401582941	DN390B LED6/840 PSU D100 WH CAU	911401578941	DN392B LED16/830 PSU D150 WH GM
911401577841	DN390B LED6/840 PSU D100 WH GM	911401579841	DN392B LED16/830 PSU D200 ALU GM
911401583741	DN390B LED6/840 PSU D100 WH WP CAU	911401583241	DN392B LED16/830 PSU D200 WH CAU
911401578241	DN390B LED6/865 PSU D100 ALU GM	911401579541	DN392B LED16/830 PSU D200 WH GM
911401580941	DN390B LED6/865 PSU D100 ALU WP GM	911401585741	DN392B LED16/840 PSD D150 ALU GM
911401577941	DN390B LED6/865 PSU D100 WH GM	911401584941	DN392B LED16/840 PSD D200 ALU CAU
911401584441	DN391B LED11/830 PSD D150 ALU CAU	911401582341	DN392B LED16/840 PSD D200 ALU GM
911401581841	DN391B LED11/830 PSD D150 ALU GM	911401584741	DN392B LED16/840 PSD D200 WH CAU
911401584241	DN391B LED11/830 PSD D150 WH CAU	911401582141	DN392B LED16/840 PSD D200 WH GM
911401581641	DN391B LED11/830 PSD D150 WH GM	911401579341	DN392B LED16/840 PSU D150 ALU GM
911401578641	DN391B LED11/830 PSU D150 ALU GM	911401579041	DN392B LED16/840 PSU D150 WH GM
911401581041	DN391B LED11/830 PSU D150 ALU WP GM	911401579941	DN392B LED16/840 PSU D200 ALU GM
911401583041	DN391B LED11/830 PSU D150 WH CAU	911401583341	DN392B LED16/840 PSU D200 WH CAU
911401578341	DN391B LED11/830 PSU D150 WH GM	911401579641	DN392B LED16/840 PSU D200 WH GM
911401583841	DN391B LED11/830 PSU D150 WH WP CAU	911401579441	DN392B LED16/865 PSU D150 ALU GM
911401584541	DN391B LED11/840 PSD D150 ALU CAU	911401579141	DN392B LED16/865 PSU D150 WH GM
911401581941	DN391B LED11/840 PSD D150 ALU GM	911401580041	DN392B LED16/865 PSU D200 ALU GM
911401584341	DN391B LED11/840 PSD D150 WH CAU	911401579741	DN392B LED16/865 PSU D200 WH GM
911401581741	DN391B LED11/840 PSD D150 WH GM	911401585241	DN393B LED22/830 PSD D200 ALU CAU
911401578741	DN391B LED11/840 PSU D150 ALU GM	911401582641	DN393B LED22/830 PSD D200 ALU GM
911401581141	DN391B LED11/840 PSU D150 ALU WP GM	911401585041	DN393B LED22/830 PSD D200 WH CAU
911401583141	DN391B LED11/840 PSU D150 WH CAU	911401582441	DN393B LED22/830 PSD D200 WH GM
911401578441	DN391B LED11/840 PSU D150 WH GM	911401580441	DN393B LED22/830 PSU D200 ALU GM
911401583941	DN391B LED11/840 PSU D150 WH WP CAU	911401581341	DN393B LED22/830 PSU D200 ALU WP GM
911401578841	DN391B LED11/865 PSU D150 ALU GM	911401583441	DN393B LED22/830 PSU D200 WH CAU
911401581241	DN391B LED11/865 PSU D150 ALU WP GM	911401580141	DN393B LED22/830 PSU D200 WH GM
911401578541	DN391B LED11/865 PSU D150 WH GM	911401584041	DN393B LED22/830 PSU D200 WH WP CAU
		911401585341	DN393B LED22/840 PSD D200 ALU CAU
		911401582741	DN393B LED22/840 PSD D200 ALU GM
		911401585141	DN393B LED22/840 PSD D200 WH CAU
		911401582541	DN393B LED22/840 PSD D200 WH GM
		911401580541	DN393B LED22/840 PSU D200 ALU GM
		911401581441	DN393B LED22/840 PSU D200 ALU WP GM
		911401583541	DN393B LED22/840 PSU D200 WH CAU
		911401580241	DN393B LED22/840 PSU D200 WH GM
		911401584141	DN393B LED22/840 PSU D200 WH WP CAU
		911401580641	DN393B LED22/865 PSU D200 ALU GM
		911401581541	DN393B LED22/865 PSU D200 ALU WP GM
		911401580341	DN393B LED22/865 PSU D200 WH GM

SWJ

SZUTEST

CE
2195

Certificate of Conformity of the Factory Production Control 2195-CPR-1417702

In compliance with *Regulation 305/2011/EU of the European Parliament and of the Council of 9 March 2011* (the Construction Products Regulation or CPR), this certificate applies to the construction product

Cold formed welded structural hollow sections of non-alloy steels made of the following steel grades;

(tested for performance for the characteristics described in Annex 1 which is an inseparable part of this certificate)

produced by the manufacturer

SHANGHAI JIALENG ROLL FORMING TECHNOLOGY CO., LTD

No. 558, Xingshun Road, Jiading, Shanghai, P.R. China

and produced in the manufacturing plant

SHANGHAI JIALENG ROLL FORMING TECHNOLOGY CO., LTD

No. 558, Xingshun Road, Jiading, Shanghai, P.R. China

This certificate attests that all provisions concerning the assessment and verification of constancy of performance described in Annex ZA of the standard(s)

EN 10219-1: 2006

under system 2+ are applied and that the factory production control is assessed to be in conformity with the applicable requirements. This certificate was first issued on 26th June 2014, renewed on 26th June 2020 and will remain valid as long as neither the harmonised standard, the construction product, the assessment and verification of constancy of performance methods nor the manufacturing conditions in the plant are modified significantly, unless suspended or withdrawn by the notified factory production control certification body. The certificate is supported through annual surveillance audit and is reissued after each surveillance audit. This certificate should be reissued not later than 26th June 2021.

İker Elinc ELINC
Head of Construction Products Department

SZUTEST UYGUNLUK DEĞERLENDİRME A.Ş.
Tatlısu Mahallesi, Akif İnan Sk. No:1 Ümraniye 34774 İSTANBUL / TÜRKİYE

Szutest.com.tr

Certificate of Conformity of the Factory Production Control

2195-CPR-1417702

Annex 1

Intended uses;

To be used in metal structures or in composite metal and concrete structures.

Controlled Performance Characteristics;

- Dimension and Shape Tolerances,
- Tensile Strength,
- Yield Strength,
- Elongation,
- Impact Resistance,
- Weldability.

Steel Grade	Section	Sizes
S235JRH S275J0H S275J2H	Circular Hollow Sections	Ø; from 31,8 mm up to 300,0 mm wall thickness; from 1,5 mm up to 8,0 mm
S355J0H S355J2H S275NLH S355NLH	Square Hollow Sections	from 25mm x 25mm up to 304,8mm x 304,8mm, wall thickness; from 1,5 mm up to 14,0 mm
S275MLH S355MLH S420MLH S460MH S460NH	Rectangular Hollow Sections	from 30mm x 20mm up to 406,4mm x 203,2mm, wall thickness; from 1,5 mm up to 14,0 mm

Ilker Erdiç ELİNÇ
Head of Construction Products Department

SZUTEST

CE
2195

Certificate of Conformity of the Factory Production Control

2195-CPR-1417701

In compliance with Regulation 305/2011/EU of the European Parliament and of the Council of 9 March 2011 (the Construction Products Regulation or CPR), this certificate applies to the construction product

Hot finished structural hollow sections of non-alloy and fine grain steels

(tested for performance for the characteristics described in Annex 1 which is an inseparable part of this certificate)

produced by the manufacturer

SHANGHAI JIALENG ROLL FORMING TECHNOLOGY CO., LTD

No. 558, Xingshun Road, Jiading, Shanghai, P.R. China

and produced in the manufacturing plant

SHANGHAI JIALENG ROLL FORMING TECHNOLOGY CO., LTD

No. 558, Xingshun Road, Jiading, Shanghai, P.R. China

This certificate attests that all provisions concerning the assessment and verification of constancy of performance described in Annex ZA of the standard(s)

EN 10210-1: 2006

under system 2+ are applied and that the factory production control is assessed to be in conformity with the applicable requirements. This certificate was first issued on 26th June 2014, renewed on 26th June 2020 and will remain valid as long as neither the harmonised standard, the construction product, the assessment and verification of constancy of performance methods nor the manufacturing conditions in the plant are modified significantly, unless suspended or withdrawn by the notified factory production control certification body. The certificate is supported through annual surveillance audit and is reissued after each surveillance audit. This certificate should be reissued not later than 26th June 2021.

İlker Eroling ELİNG
Head of Construction Products Department

FR: CPR: 24 R: 01

SZUTEST UYGUNLUK DEĞERLENDİRME A.Ş.
Tatlısu Mahallesi, Akif İnan Sk. No:1 Ümraniye 34774 İSTANBUL / TÜRKİYE

Szutest.com.tr

Certificate of Conformity of the Factory Production Control

2195-CPR-1417701

Annex 1

Intended uses;

To be used in metal structures or in composite metal and concrete structures.

Controlled Performance Characteristics;

- Dimension and Shape Tolerances,
- Tensile Strength,
- Yield Strength,
- Elongation,
- Impact Resistance,
- Weldability.

Steel Grade	Section	Sizes
S235JRH S275J0H	Circular Hollow Sections	Ø; from 31,8 mm up to 300,0 mm wall thickness; from 1,5 mm up to 8,0 mm
S275J2H S355J0H S355J2H	Square Hollow Sections	from 25mm x 25mm up to 304,8mm x 304,8mm, wall thickness; from 1,5 mm up to 14,0 mm
S355K2H S275NLH S355NLH	Rectangular Hollow Sections	from 30mm x 20mm up to 406,4mm x 203,2mm, wall thickness; from 1,5 mm up to 14,0 mm
S420NLH S420NH S460NH	Elliptical Hollow Sections	from 120mm x 60mm up to 300mm x 150mm, wall thickness; from 1,5 mm up to 12,5 mm

Ilker Erinc ELINÇ
Head of Construction Products Department

FR: CPR_24 R:01



**EC-ATTESTATION CERTIFICATE
OF LVD**

Date, Place of Issue : 03rd of February, 2016 / Istanbul

Applicant : Shanghai Weyer Electric Appliances Co., Ltd.
No. 6-8, Hangming Road, Hangtou Town, Pudong New Area, Shanghai, China

Manufacturer : Shanghai Weyer Electric Appliances Co., Ltd.
No. 6-8, Hangming Road, Hangtou Town, Pudong New Area, Shanghai, China

Description of Product : Metal Conduit

Model(s) : JSH, JSH-PVC; JSH-PU; JSB; JSB-PU; JSC; JSC-TG #
JSG-TG-1S; SLSH; SLSH-PVC; SL; SUS; WEYERgraff-PU-AS #
WEYERgraff-CU-AD; SPR-AS; SPR-PVC-AS; WEYERgraff-AS #
SPR-PU-AS

Reference Standard(s) : EN 61386-1:2008; EN 61386-23:2004/A11:2010 #

TCF Reference No. : TCF-LVD-160201-026 (OUCE 161213)

Date of Assessment : 11th January 2016

Assessment Performed : Assesses for compliance with the requirements of Annex IV's applicable paragraphs of the Low Voltage Directive 2006/95/EC.

Conclusion : In the opinion of SGS the submitted technical file referenced as TCF-LVD-160201-026 (OUCE 161213) satisfies the requirements of the Low Voltage Directive 2006/95/EC.

This certificate is valid as long as the relevant directives and harmonised standards written above are current.

The CE mark as shown below can be used, under the responsibility of the manufacturer, after completion of an EC Declaration of Conformity and compliance with all relevant EC Directives.



This certificate refers only to the sample submitted to SGS Supervise Gözetme Etüd Kontrol Servisleri A.Ş. for testing and certification. This certificate shall not be reproduced except in full without the written approval of SGS Supervise Gözetme Etüd Kontrol Servisleri A.Ş.

This certificate is issued by the Company subject to its General Conditions of Service available upon request and accessible at www.sgs.com. Attention is drawn to the limitations of liability, indemnification, jurisdictional, representative restrictions of test samples and sample retention policies defined therein.

For and on behalf of
SGS Supervise Gözetme Etüd
Kontrol Servisleri A.Ş.
M. İdris KOCAYARIN

Alt. Osman ÖZTÜRK

SGS Supervise Gözetme Etüd Kontrol Servisleri A.Ş.
Bağlar Mah. Osmanpaşa Cad. No.95
İş İstanbul Plaza, A Girişi
Güneşli 34209 İstanbul - TURKEY
t: 90.212.3684000 (Pbx)
f: 90.212.2964782-83
e: sgs_turkey@sgs.com

This document is issued, on the Client's behalf, by the Company under its General Conditions of Service printed overleaf.
The Client's attention is drawn to the limitation of liability, indemnification and jurisdiction issues defined therein.



Any other holder of this document is advised that information contained hereon reflects the Company's findings at the time of its intervention only and within the limits of Clients instructions, if any. The Company's sole responsibility is to the Client and this document does not exonerate parties to a transaction from exercising all their rights and obligations under the transaction documents.



DECLARATION DE CONFORMITE DECLARATION OF CONFORMITY

N° A 1 / 2012

APPAREIL(S) : 2P+E socket outlets BS ARTEOR
SAMPLE DESCRIPTION :

REFERENCE(S) : 572111
REFERENCE(S) :

CARACTERISTIQUES : 13A 250V~
RATED CHARACTERISTICS :

CET (CES) APPAREIL(S) EST (SONT) CONFORME(S) :
THIS (THESE) DEVICE(S) IS (ARE) IN ACCORDANCE WITH :

the standard BS 1363 part 2 (1995) + A1 (1997) + A2 (2003) + A3 (2007)

The conditions and the results of tests are recorded in the file 7191001669-EEC11/01-YKF establish by the PSB singapore

Cette déclaration comprend : 1 page

This declaration contains : 1 page

Date de délivrance : 05/01/2012
Issue date :

Responsable du Laboratoire Produits Central
Head of test Laboratory
Jean-Marc LIBOUTET

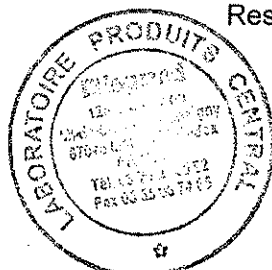

La reproduction de ce document n'est autorisée que sous la forme de fac-similé photographique intégral. Toute reproduction partielle ou toutes insertions de résultats dans un texte d'accompagnement en vue de leur diffusion doit recevoir un accord préalable et formel de LEGRAND. Ce document résulte d'essais effectués sur un échantillon. Il ne préjuge pas de la conformité des produits fabriqués à l'objet essayé. This document shall not be reproduced, except as a complete photographic facsimile. Any partial reproduction, as well as the insertion of any results into an accompanying text for distribution, requires the prior written approval of LEGRAND. This document contains results related only to the items tested. It does not imply the conformity of the whole production to the items tested. LEGRAND - 128, Avenue du Mal-de-Lattre-de-Tassigny - F 87045 LIMOGES Cedex - Tél. : (33) 05.55.06.84.66

Installation Instruction

1. Introduction

1.1 Intension

Thanks for your using our flat packed houses; here it is the installation instruction which can help you install the container house quickly, safely and exactly for your reference.

1.2 Safety

Before installation, please put the products into the right place which have already planned. Please make sure the ground is flat and clear understand the materials. The workers should take the safety helmet, glove for safety security.

2. Organization

Each hospital site has 34 construction personnel, including 1 structural engineer, 1 electrical engineer, 4 cranes, 4 crane drivers and 24 workers. The workers are divided into 4 groups, 6 people in each group, 4 groups work at the same time.

3. Assembly Procedure

(1) Unpacking the package

Choose a pallet and solid ground where the container house is to be installed. Taking the steel structures, wall panels and other related accessories out of the containers, and then place them around the place orderly for the installation.

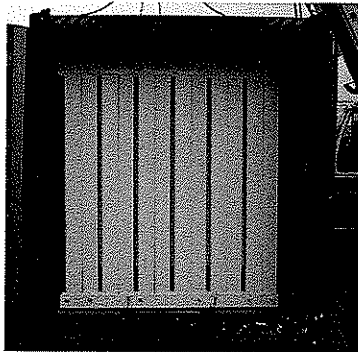

6 sets roof and base

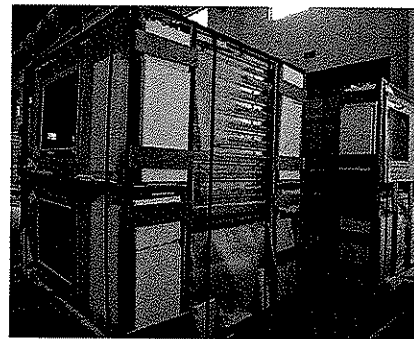

Wall panels

(2) Structure Installation

1) **Bottom Frame:** Put the bottom structure into the solid ground and the bottom frame in the level position with the balance rulers

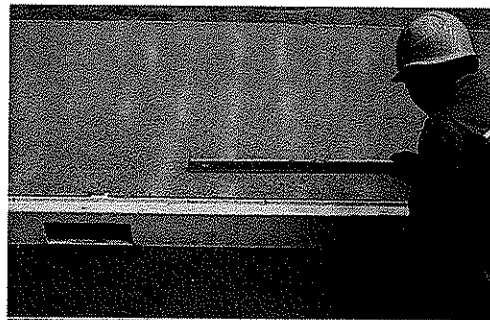

ensure

2) **Corner Posts Installation:** Making

the corner post holes match corner fittings holes of base structure. Fixing the four corner posts

the

roughly by using the supplied high-strength bolts.

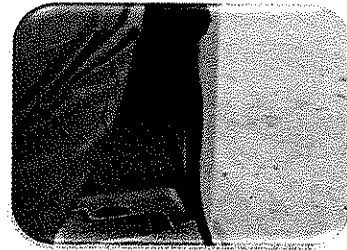
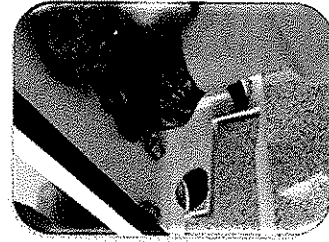

- 3) **Top frame installation:** Place the top frame to the top of the corner posts with the crane, and then fix the corner posts and top frame by using the high-strength bolts. Finally, fasten all the bolts with the manual wrench to ensure the bottom, roof frame and corner posts are fixed firm and reliable.

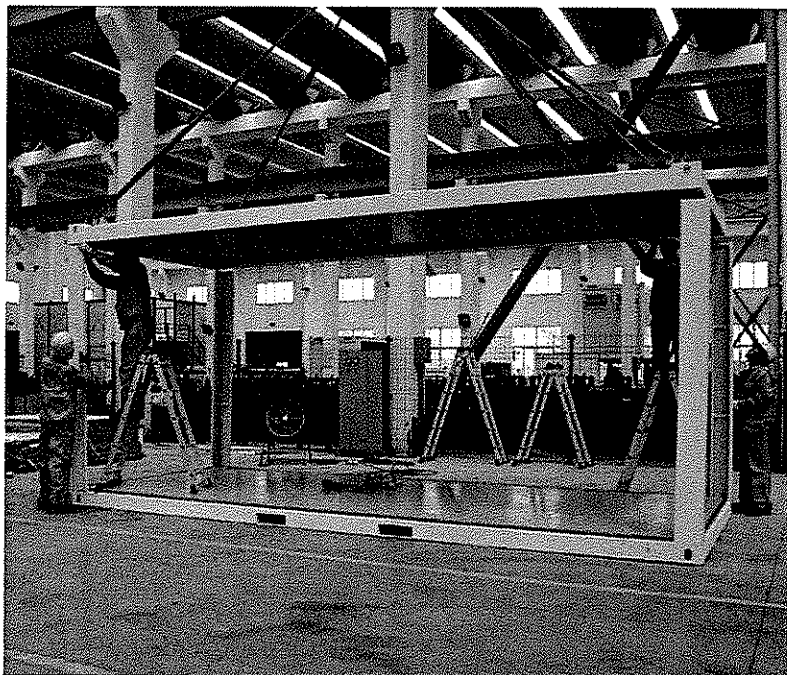

4) **Wall Panels Installation**

Place the wall panels according to the layout or according to your own requirements. The 14 panels are interchangeable.

You should install the front wall panels and the end wall panels, then you could install the side wall panels.

When you install the wall panels, you could remove the cladding films of the top about 30cm first. This will easy for you to remove all the cladding films on the wall panels when you finished all the installation.

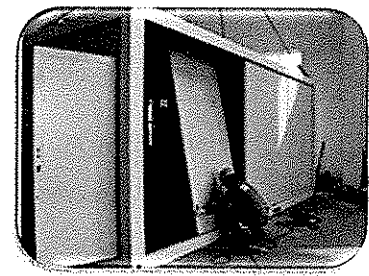
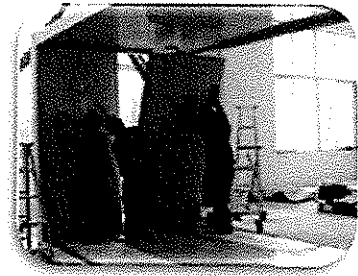

Attention:

- a. Top clamp block: Insert the Top clamp block into the top of the side panels by using the fastening bolt and washer.

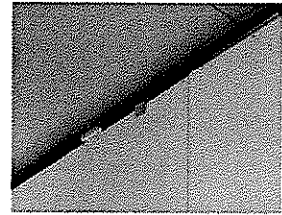
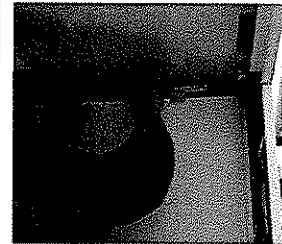
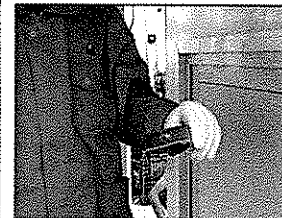
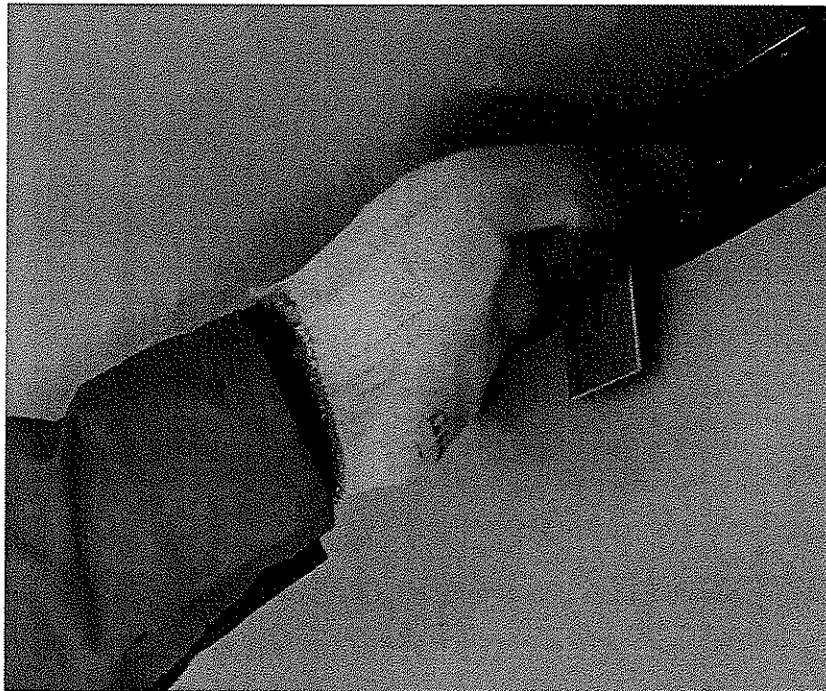

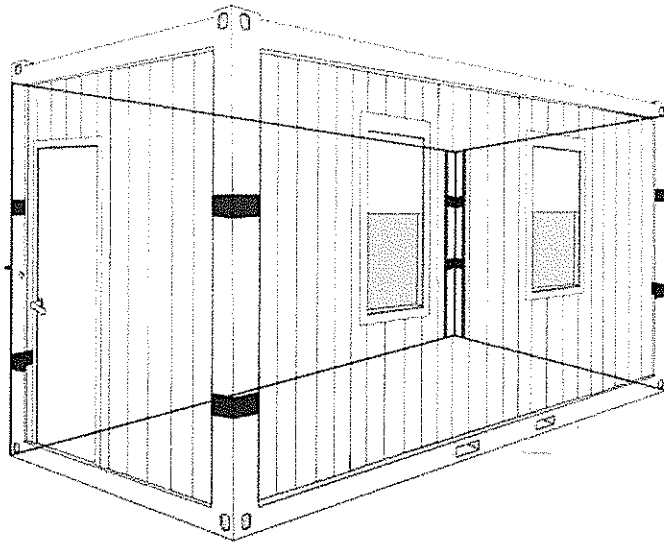

Details of the position of the check block inside the corner posts

c. Insert threaded iron rods. When assemble the left and right wall panels, don't forget to insert the threaded iron rods to the both sides of the third panels. And fastened with the locking plates, bolts and washers.

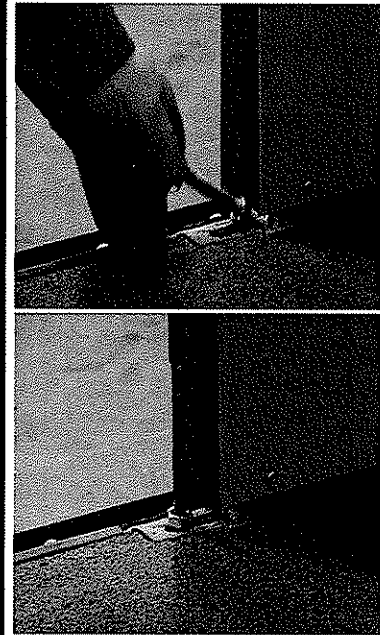

5) Fit the PVC drain pipes

Fit the PVC pipes inside the four corner posts, the installation interface correspond to the position of drain gully.

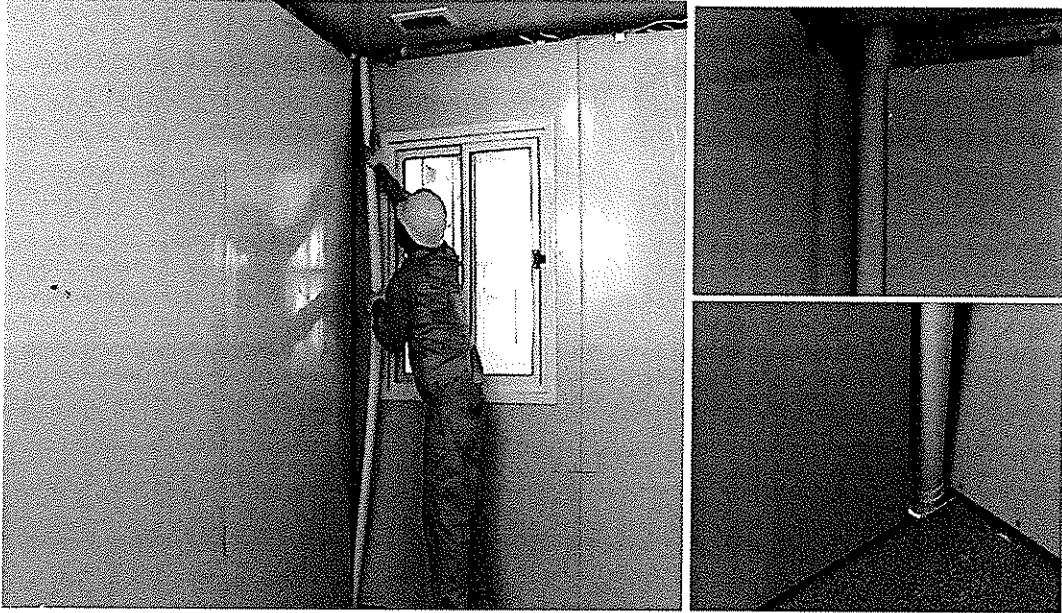

(3) Electrical Installation

Attached are just some pictures for your reference.

1) Electrical wirings installation

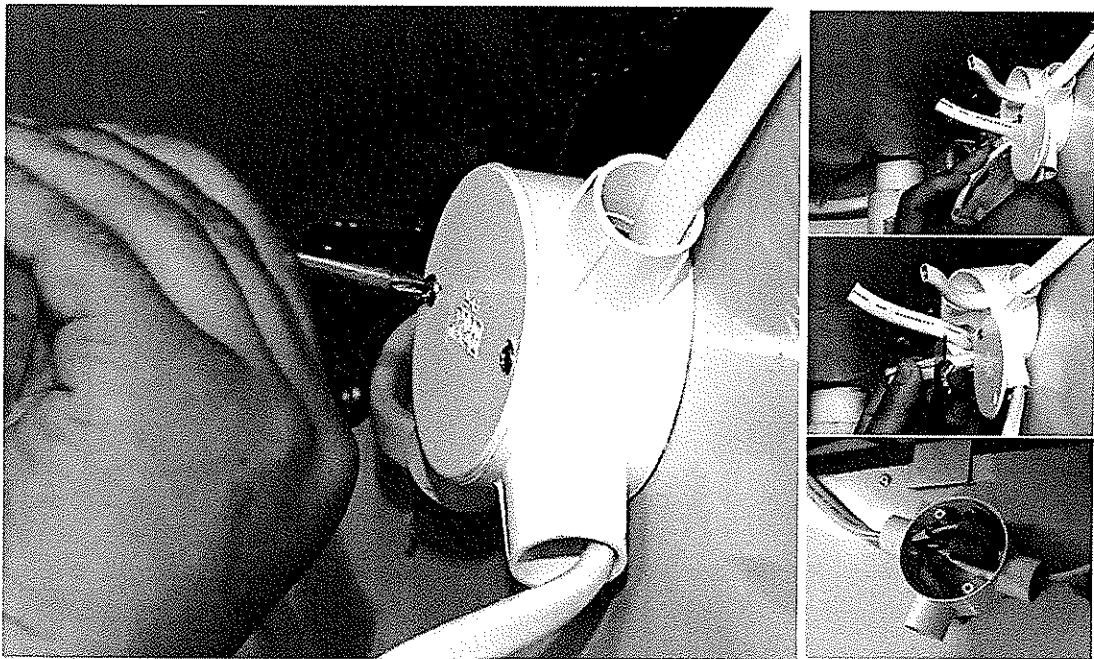

2) Lights installation

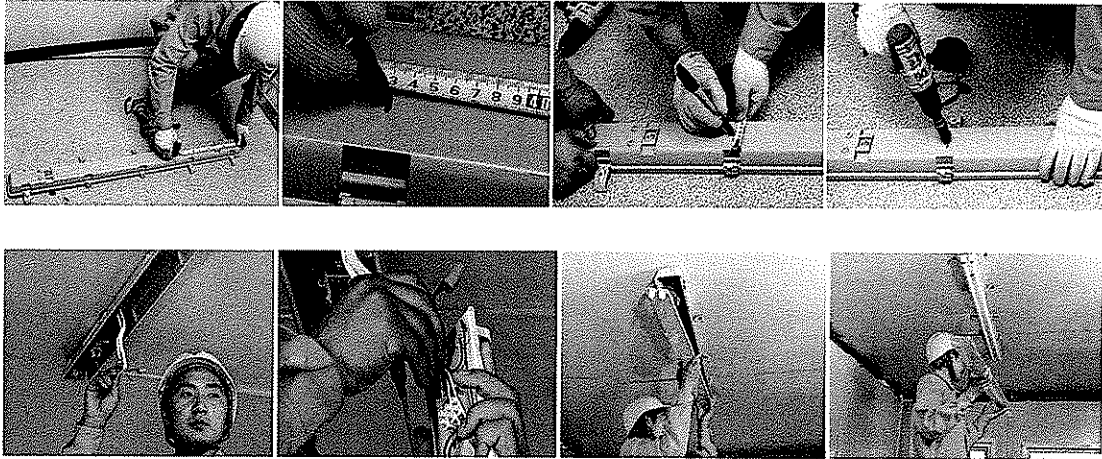

(4) Internal decoration

- 1) **Baseboard Installation:** Remove the cover of the baseboard first then fixed it with self-tapping screws and re-cover the strips. Make the angle of the corner is 90°

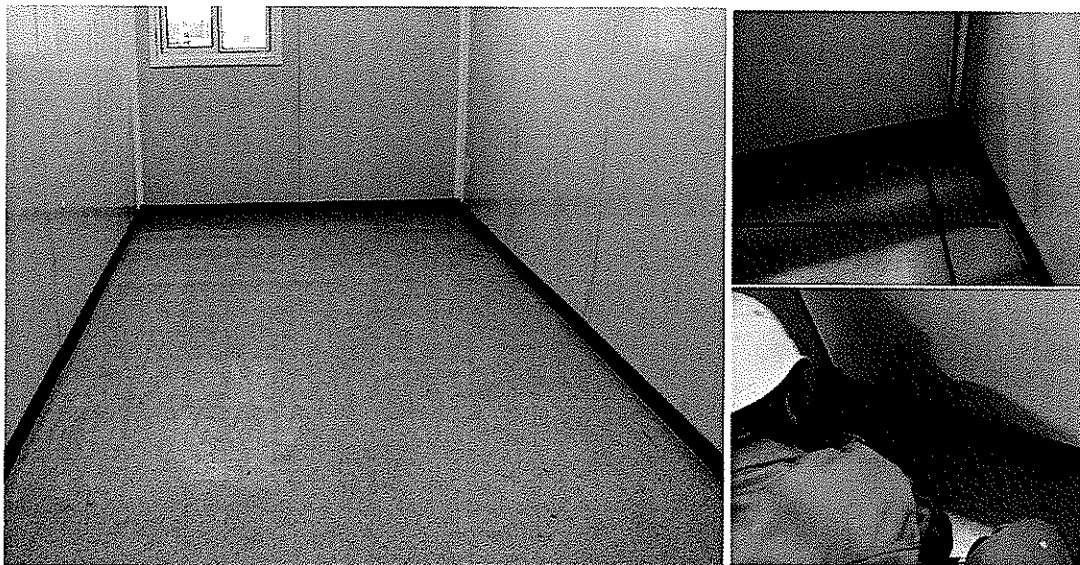

- 2) **Top molding and side molding Installation:** attach the top molding and corner molding with screw to the top and the corner posts, fasten with rivets. Then attach the covering according to the corresponding color of the top molding and corner molding.

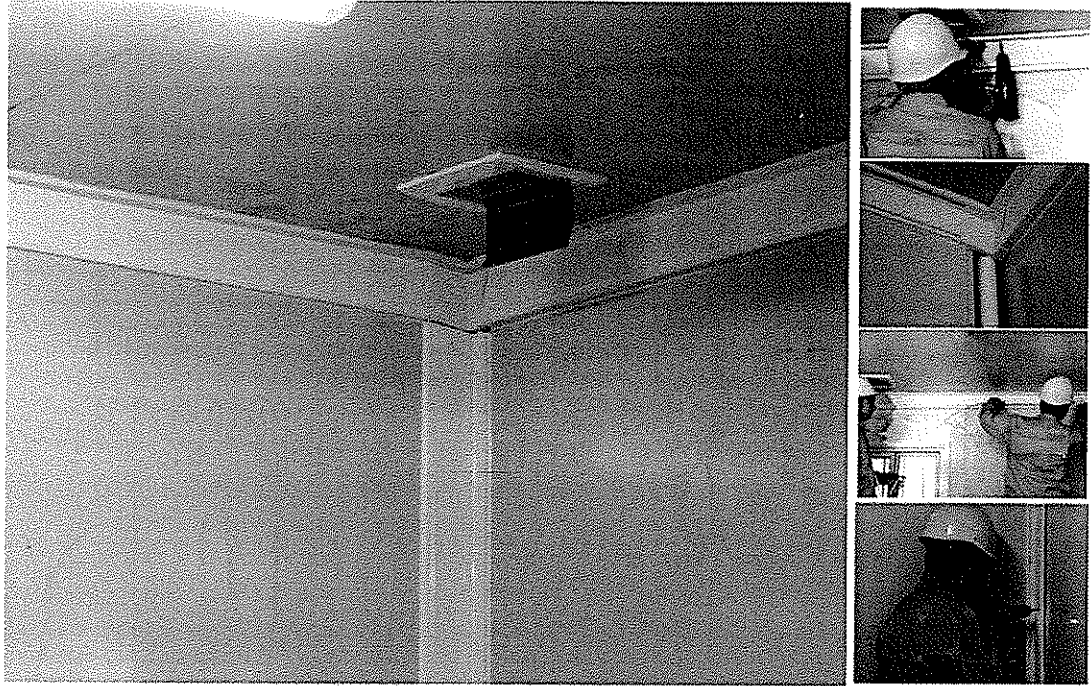

2) Door header and lock

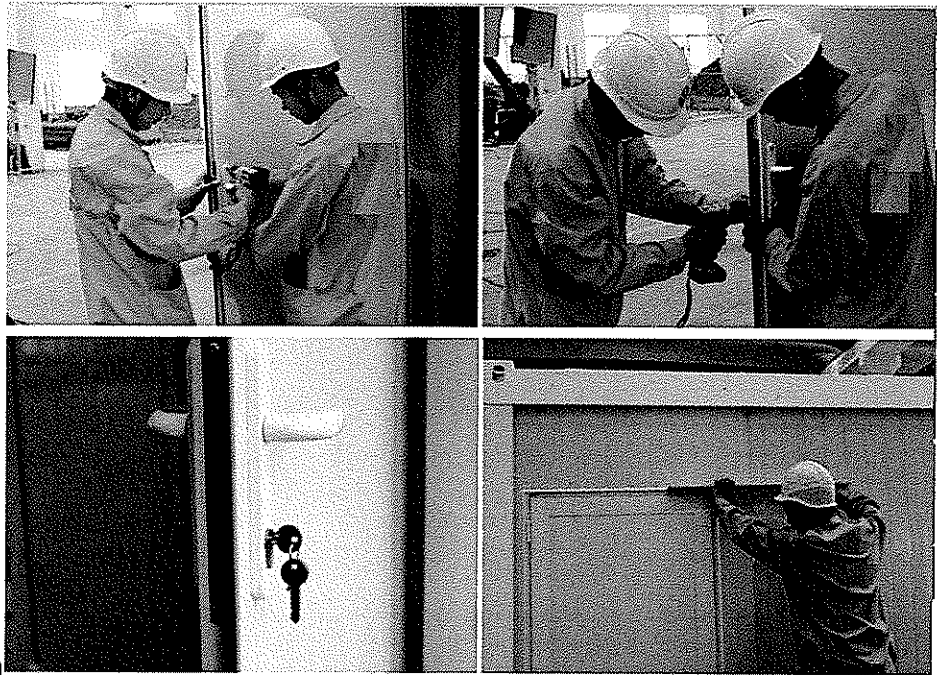

(5) Installation

Seal the junctions with silicon and remove the cladding film

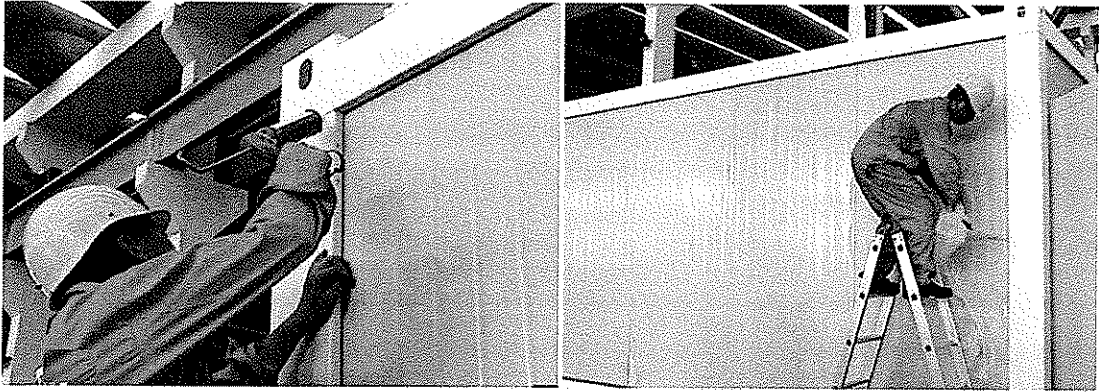

(6) Finishing

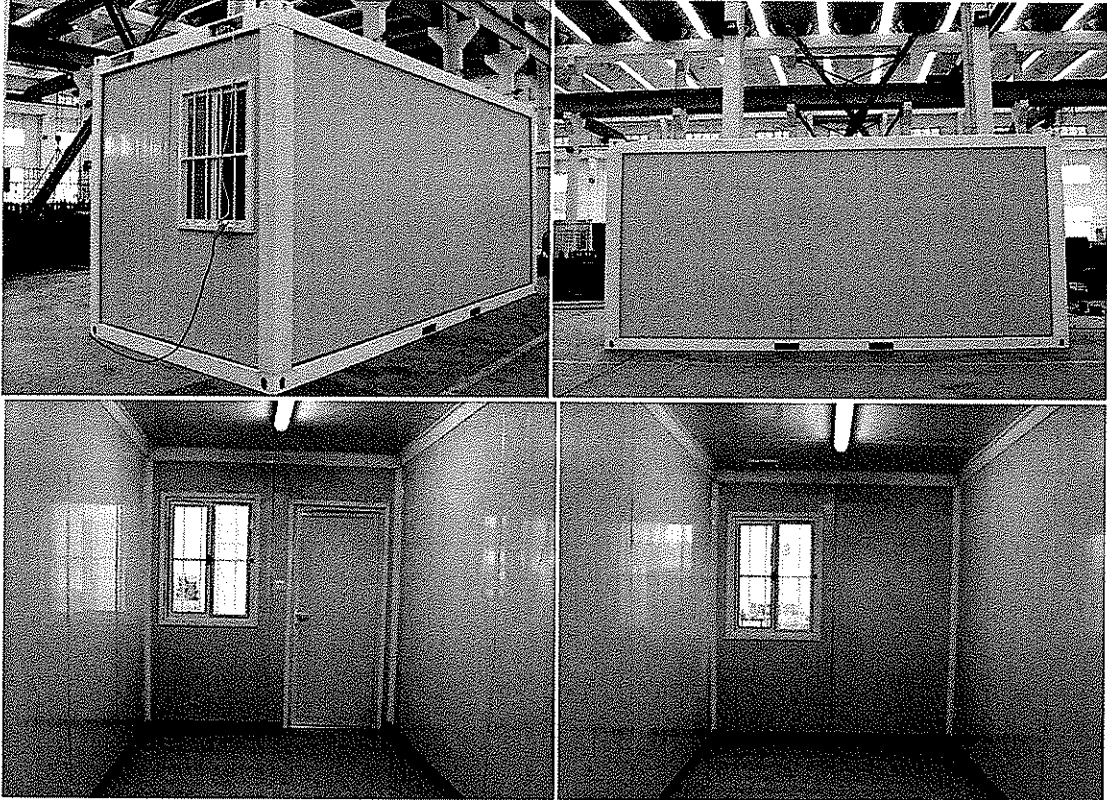

SECTION 4 - ABOUT MANUFACTURER AND DESIGN INSTITUTE

常熟雅致模块化建筑有限公司

CHANGSHU YAHGEE MODULAR CO., LTD.



公司简介

INTRODUCTION

目录

雅致成立于2001年，是隶属于香港招商局集团的中國南山开发(集团)股份有限公司的控股企业。在常熟、佛山、廊坊等地设有分子公司。雅致一直致力于新型集成建筑的开发和经营，拥有打包箱、特种集装箱、模块化建筑等系列产品，是中国集成建筑领导者。

Yahgee was established in 2001, with China Nanhai Development(Group) Incorporation as the majority share holder, and is the subsidiary enterprise of China Merchants Group, with a number of branch companies across China, including Changshu, Foshan, Langfang. Yahgee is always devoting to the development and operation of the prefabricated buildings. Now Yahgee has developed Flat Pack, Special Container and Modular House. Yahgee is the leading company of modular buildings in China.



公司简介
INTRODUCTION



实力优势
STRENGTH



制造基地
BRANCH COMPANIES

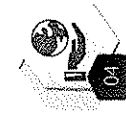

雅致产品
YAHGEE PRODUCTS



合作客户
COOPERATING ENTERPRISES

发展历程 DEVELOPMENT HISTORY

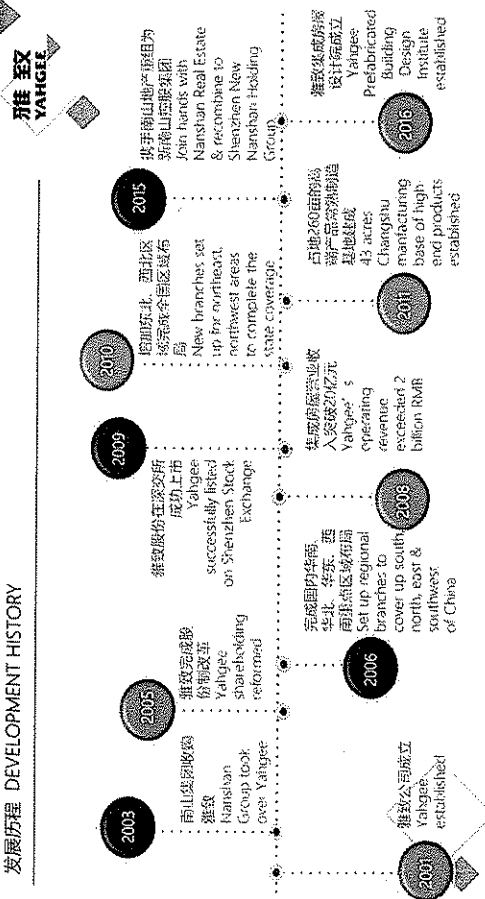

公司简介 COMPANY PROFILE

背景 Back Ground

- 创立于1872年，招商局地产开发集团，在中央企业中排名非常靠前。Founded in the Self-strengthening Movement in 1872, CMO is a leading state-owned conglomerate based in Hong Kong, also the most fast-growth state-owned company in China.
- 深圳招商南山控股(集团)股份有限公司 股票代码“南山控股” 证券代码 002314
- The first listed company with manufacture and operation of the prefabricated building as its main business in China

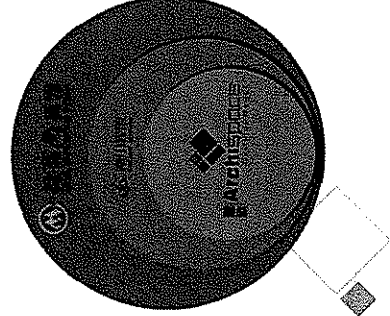

企业文化 CORPORATE CULTURE

企业愿景 Corporate Vision
成为全球最受信赖的精装房屋运营商。
To be the world's most reliable operator of prefabricated buildings

企业使命 Corporate Mission

致力于装配式房屋的开发、经营，以专业、高效、优质的产品和服务满足社会需求，成为最具竞争力的行业领导者，创造最大价值回报股东、员工和社会。
Devoting to the development and operation of the prefabricated buildings. To satisfy the up-to-date requirements from all aspects with our professional, efficient and quality products and services.
To become the most competitive leading company in the prefab housing industry.

企业价值观 Corporate Values
务实 创新 高效 和谐
Pragmatic Innovation Efficiency Harmony

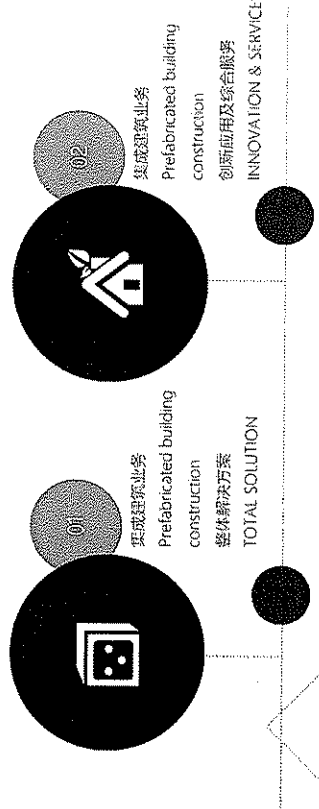

主营业务 MAIN BUSINESS





02

实力优势

STRENGTH

国际市场覆盖 INTERNATIONAL MARKET COVERAGE

雅致在华南、华东区域分别建立了专业的国际营销中心和技术队伍，拥有在全国各大港口发货的地域优势，各类建筑房屋产品远销世界一百多个国家地区。

Yahgee has professional international sales with technician departments set up in south & east of China, with the advantages of deliver products out from all major ports of China. Yahgee's products are widely built up and used in over 100 countries and areas in the world.



雅致公司在汶川大地震、玉树地震、台湾地震等型大自然灾害发生后，第一时间投入抗震救灾行动中，出色地完成了每一次抗震救灾任务。同时受到国家各级领导的高度肯定与亲切关怀。

During the Wenchuan, Yushi & Taiwan earthquakes, Yahgee unreservedly took part and played an important role to support people suffered from the disasters and reconstruct the sites with remarkable achievements, which was highly recognized by the society and the national leaders.



社会责任 RESPONSIBILITY & CONTRIBUTION

<p>We offered nearly 17,000 square meters of temporary houses</p>	<p>汶川地震 提供约17000平方米临时住房</p>	
<p>800 sets of rescue supplies provided by the Ministry of Health</p>	<p>台湾地震 台湾医疗中心提供800套医疗物资</p>	
<p>2000m² emergency houses donated to relief hospital.</p>	<p>玉树地震 公司紧急捐赠2000平方米安置房，作为临时救灾医院使用</p>	
<p>Helps support disaster reconstruction. We are a High Reputation.</p>	<p>日本地震 支援灾后重建，赢得很高声誉</p>	
<p>Finished 35000 square meters of housing construction works.</p>	<p>房山冰灾 完成2.65万平方米安置房建设任务</p>	
<p>Donated more than 2800 square meters plastic sheets.</p>	<p>雅安地震 捐赠2000多平方米活动房</p>	

国际认证 CERTIFICATIONS

雅致一直以來十分注重企業管理規範，並積極通過專業資質認證完善公司管理印企業運作。Yahgee has always been focusing on improving the business management and has granted a number of certifications and qualifications of managements, services and products.

雅致 YAHGEE

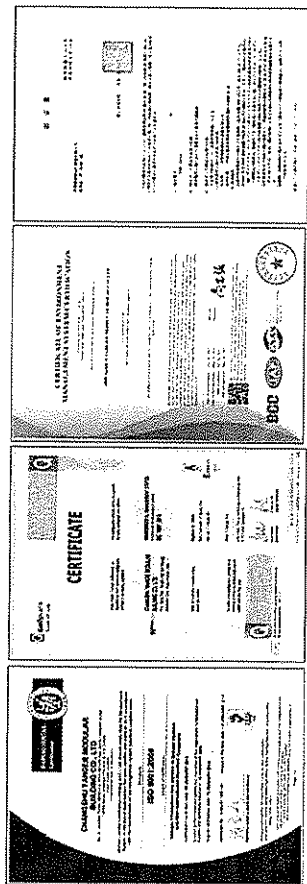

ISO 9001 國際標準化組織
ISO 9001:2008 Certified by BV

ISO 14001 環境管理體系
ISO 14001:2005 Certification

BSI 英國標準協會
BSI 21565:2005/2007/2012/2015/2018

中國建築業協會
JC Certification

實力優勢 STRENGTH ADVANTAGES

雅致 YAHGEE

① 是澳洲、歐洲、日本、東南亞、非洲等國家永久和半永久集成型廠的承建商
The dominant supplier of permanent and temporary prefabricated buildings of Australia, Europe, Japan, Southeast Asia and African countries.

② 是中建集團、中鐵集團、招商局集團等港多和名企業集團的主要供應商
The primary contractor of China State Construction, China Railway Construction, China Resources, China Macintosh and many other well-known enterprise companies.

③ 是國家“一帶一路”戰略的參與者與踐行者
The participant and practitioner of the national strategy of "the Belt and Road Initiative".

④ 是海務部、民政部、總商會、聯合國救災等政府組織或房屋採購的重要伙伴
The significant partner of Commerce Department, Civil Affairs Department, General Logistics Department, UNDRR and etc. referring prefabricated building.

⑤ 是世界災後重建領域的核心骨干
The core backbone in the field of post-disaster reconstruction of the world.

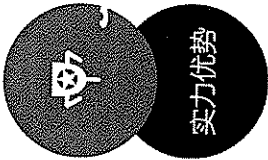

国际认证 CERTIFICATIONS

雅致 YAHGEE

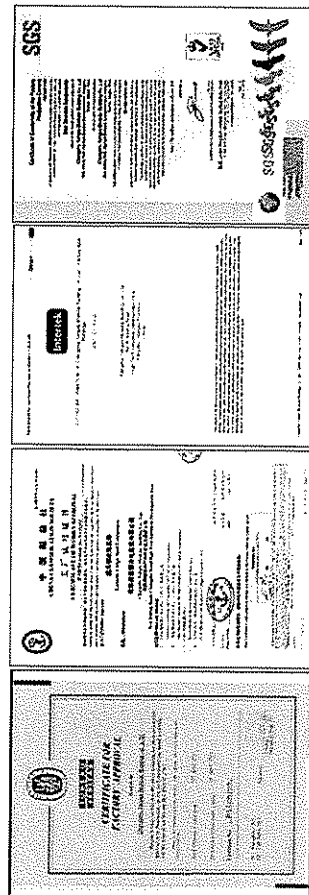

中國建築業協會
JC Certification

中國建築業協會
JC Certification

英國標準協會
BSI Certification

英國標準協會
BSI Certification

国家标准编制 NATIONAL STANDARDS COMPILATION

雅致作为主编单位，多次参加由中华人民共和国住房和城乡建设部提出的关于《装配式轻钢结构活动房屋》GB/T 29740-2013、《装配式轻钢结构活动房 第一部分可拆装配式》(申报中) 以及《箱式轻钢结构活动房 第一部分 整体式》(申报中) 国家标准的编制。

As the editor-in-chief association, Yahgee has participated in a number of national standards compilations proposed by the Housing and Urban Development Department of PRC, including "Dismountable LGS Prefab Housing" (GB/T 29740-2013), "Modular LGS Prefab Housing Part I - Dismountable Type" (under Declaring), "Modular LGS Prefab Housing Part II - Integral Type" (under Declaring) and etc.

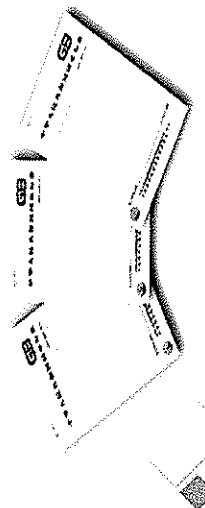
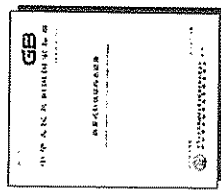

荣誉资质 HONORARY AWARDS

雅致 YAHGEE

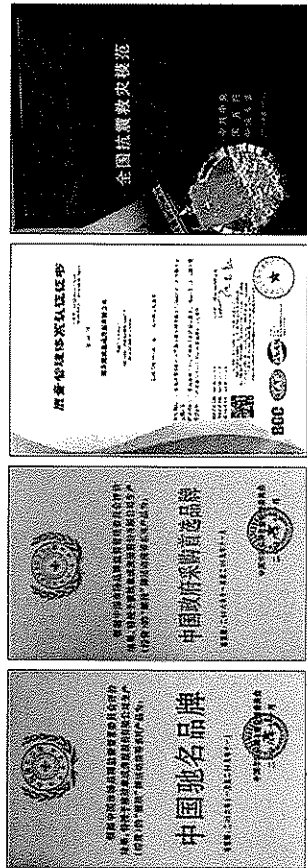

国际认证 CERTIFICATIONS

雅致 YAHGEE

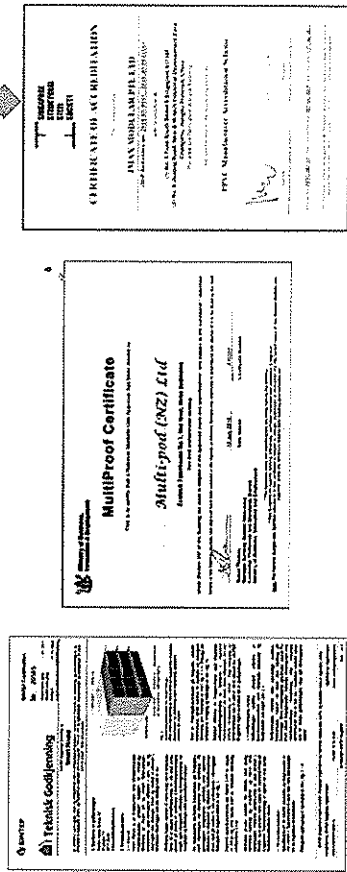

新西兰注册
New Zealand
New Zealand V-Approved Certifications

新加坡注册
Singapore
Singapore PPGC Certificate

荣誉奖项 HONORARY AWARDS

雅致 YAHGEE



专利技术 PATENTS

雅致 YAHGEE

专利, 为推动中国建筑系统行业的技术进步做出了贡献。

Yahgee has strength in research and development, which has already achieved a series of scientific research outcome. There are over 60 national patents filled to Yahgee, including 4 patents of invention. Yahgee's contributions in improvement of precastributed building technology are remarkable and highly honored.

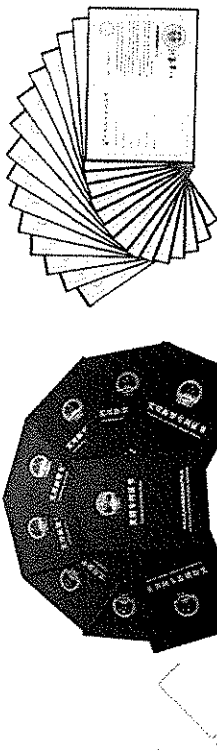

制造基地 BRANCH COMPANIES

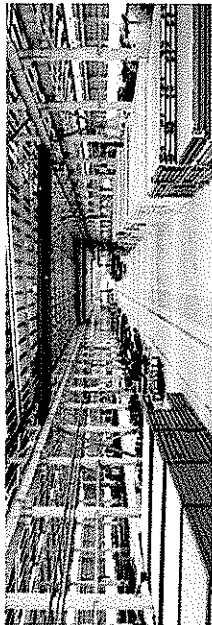

钢结构车间 Steel Structure Workshop



内装车间 Internal Finishing Workshop



涂装车间 Painting Workshop

雅致 YAHGEE

03



制造基地

BRANCH COMPANIES

制造基地 BRANCH COMPANIES

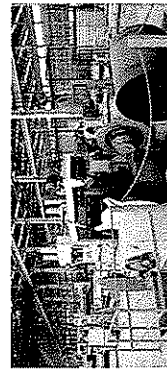

开卷机 Uncoiling Machine



折弯机 Bending Machine



打砂设备 Sanding Machine

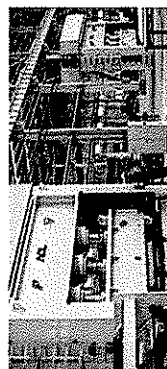

冲压设备 Pressing Machine

雅致 YAHGEE

制造基地 BRANCH COMPANIES



位置/Location:

- 中国江苏省常熟高新技术产业开发区 / New & High Tech Industrial Development Zone in Changshu, Jiangsu Province
- 距离上海港口106km / 106 km from factory to Shanghai port

工厂规模/Factory Size:

- 工厂总面积/ Overall Site 192,800m²
- 车间总面积/ Workshop Size 72,500m²
- 生产线 18000米/ 18000 long production line

常熟工厂专注于/Changshu factory Specializes on

- 模块化建筑预置结构产品和特殊规格中等高端产品的研发、生产和销售 / Manufacturing modular buildings, light gauge steel buildings, special containers and other mid-range to high-end products

年产能/Annual Production:

- 装修模块4,000套/ 4,000 units modular houses with full decoration
- 打包装18,000套/ 18,000 units flat pack houses
- 海陆集装箱200,000个/ 200,000 m² LCS buildings
- 标准箱50,000TEU/ 50,000 TEU containers

制造基地 BRANCH COMPANIES

雅致 YAHGEE

薄板打砂工艺流程
(型材打砂同此)
Workmanship of sheet sanding
(This procedure also apply to the tubes sanding)

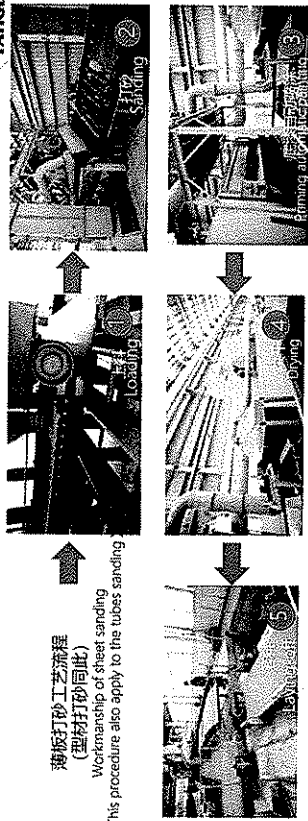

关键设备：抛丸机、打砂机和喷砂设备
关键工序：打砂、喷砂、抛丸、打磨、抛光
Key line analysis: Sheet sanding process: iron and alloy after sanding steel surface's center, with one or two times roughness by oxygen or alkali which will lead to the electrochemical reaction on the steel surface, which only can be a 16 after sanding, further result in the flourescent effect, affecting the later coating.
Note: This process is to prevent the steel surface from reacting with moisture.

制造基地 BRANCH COMPANIES

雅致 YAHGEE

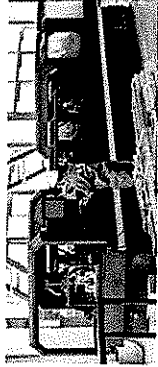

Pinnacle X5 轻钢设备
Pinnacle X5 Light Gauge Steel Equipment



多工位冲压设备
Multiple Position Pressing Equipment



钢制平台焊接平台
Steel Platform Welding Platform



力学实验室
Mechanical Laboratory

制造基地 BRANCH COMPANIES

雅致 YAHGEE



柔性组装焊接线
Flexible Sub-assembly Welding Line

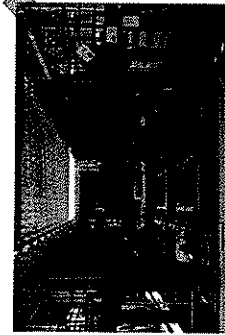

柔性组装焊接线
Flexible General-assembly Welding Line

柔性化生产使产品于不同阶段生产不同规格型材。由于大型不同规格的产品生产时除人工成本外，由此产生的设备维护成本。
For producing the changing different product with easy to ensure the accuracy price after.
柔性化的目的，就是使不同规格的产品能够在同一生产线生产，而产品规格由生产线的不同阶段进行控制。
Quality and production efficiency can both be ensured during the flexible Sub-Assembly workpiece line.

制造基地 BRANCH COMPANIES

雅致 YAHGEE

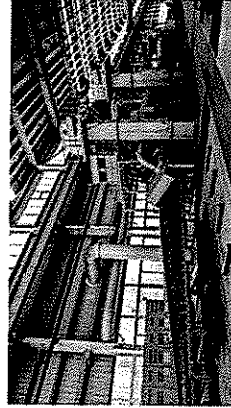

钢板打砂
Sheet sanding

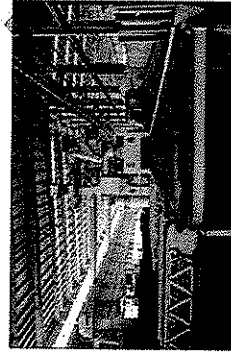

型材及厚板打砂
Tubes sanding

钢材表面处理：可在钢板表面形成氧化皮，同时在钢板表面形成微小凹坑，使钢板在涂漆时可保证涂层的附着力，提高产品的耐腐蚀性。
After the sanding process of the steel surface, can remove the rust and scale of steel surface. At the same time, the formation of small pits on the surface of steel, painting process can ensure the adhesion of paint, improve the corrosion resistance of the product.



雅致产品

YAHGEE PRODUCTS

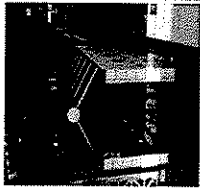

二次打砂 Second time sanding

二次打砂作用/urpose of second time sanding:

经过漆面打磨处理及底漆涂漆的钢板材料，在二次喷漆生产时，控制漆面由于漆层厚度的不均匀，形成漆膜的氧化层。二次打砂的作用/urpose of second time sanding: After the surface of the steel plate has been treated with sandblasting, the high roughness of the surface will lead to the unevenness of the coating thickness, which will cause the oxidation of the coating. The purpose of the second sanding is to make the surface of the steel plate smoother, so that the coating can be applied more evenly.

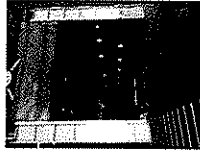

涂装线 Coating line

涂装线作用/urpose of coating line:

涂装线的作用/urpose of coating line: The coating line is used to apply the paint to the surface of the steel plate. It consists of a series of rollers and spray nozzles that apply the paint in a uniform and controlled manner. The purpose of the coating line is to ensure that the paint is applied evenly and that the coating thickness is consistent throughout the entire length of the steel plate.

涂装线作用/urpose of coating line: The coating line is used to apply the paint to the surface of the steel plate. It consists of a series of rollers and spray nozzles that apply the paint in a uniform and controlled manner. The purpose of the coating line is to ensure that the paint is applied evenly and that the coating thickness is consistent throughout the entire length of the steel plate.

涂装线作用/urpose of coating line: The coating line is used to apply the paint to the surface of the steel plate. It consists of a series of rollers and spray nozzles that apply the paint in a uniform and controlled manner. The purpose of the coating line is to ensure that the paint is applied evenly and that the coating thickness is consistent throughout the entire length of the steel plate.

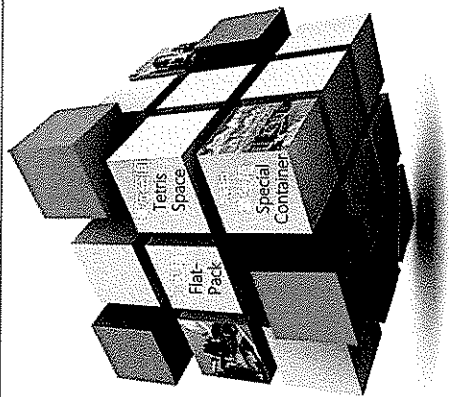

雅致产品 Yahgee Products

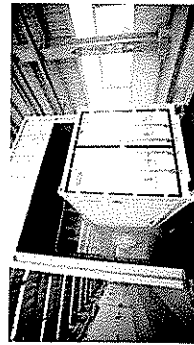

全自动水雾测试喷淋房 Watertight Test Room

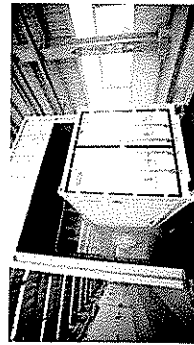

钢结构力学实验室 Mechanics Lap

水雾测试的目的/urpose of watertight test: The purpose of the watertight test is to ensure that the containers are able to withstand water ingress under various conditions. This is done by spraying water onto the containers from all angles and at different pressures. The test is performed in a watertight test room, which is a specially designed facility for this purpose.

钢结构力学实验室的作用/urpose of mechanics lap laboratory: The purpose of the mechanics lap laboratory is to test the strength and integrity of the lap joints between steel plates. This is done by applying a load to the lap joint and measuring the displacement and stress. The test is performed in a mechanics lap laboratory, which is a specially designed facility for this purpose.

我们的产品质量/quality of our products: Our products are made from high-quality materials and are manufactured using advanced technology. This ensures that our products are of the highest quality and are able to withstand the most demanding conditions. Our products are also designed to be easy to use and maintain, making them a great choice for anyone looking for a reliable and durable solution.

特种箱 SPECIAL CONTAINER

1.0 移动设备箱

移动设备箱用于满足设备的移动运输要求，广泛应用于电力、铁路、公路、水利、石油和矿产等领域。其结构便于整工厂集成化及设备的安装及检修，可根据客户要求对箱体做保温、隔热、降噪等处理，也可为客户做其他解决方案。移动设备箱主要有发电机组箱、移动配电箱、光伏箱、应急电源箱、水处理设备箱、通讯设备箱等。

Equipment containers are for equipment transportation. They are widely used in power industry, rail and road transportation, water conservancy, oil field, military and etc. For easy installation and maintenance of equipment, the structure, insulation, ventilation, acoustic performance and others of containers can be specially designed. Equipment containers generally include power generator containers, distribution containers, photovoltaic inverter containers, emergency power containers, sewage treatment containers, telecommunication containers and etc.

2.0 仓储箱

Storage Container

3.0 非标物流箱

非标物流箱并不遵循标准尺寸，根据用途和客户的具体需求，在结构方面进行了特殊设计和制造的集装箱。

The non-standard shipping container we show do not follow the ISO standards, but designed and made according to the purpose and clients' requirements.

特种集装箱 SPECIAL CONTAINER



特种箱 SPECIAL CONTAINER

1.0 模块数据中心

Modular Data Center

模块化数据中心是IT硬件系统与通信结构系统、供电系统、制冷系统、综合布线系统、智能管理系统、消防、安防等子系统高度集成全部集成到集装箱内，从而构建一个高度集成、高可用性、智能化、多种应用用途的数据中心。雅致根据客户的特殊需求以专业的设计和制造能力，为您提供可定制生产的模块化数据中心。

Modular Data Center is the types of container which consists of the hardware and software structure system, electrical system, cooling system, water supply system, communication system, power system, etc. In addition, it includes a highly integrated, flexible, scalable and multi-functional data center. Yahgee aims to provide the customized data center to our clients with professional design and ability.

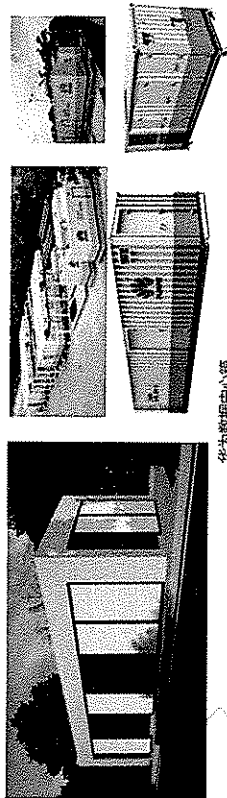

华为数据中心
Huawei Data Center

特种箱 SPECIAL CONTAINER

随着自动化程度的发展，越来越多的设备、物流、作业平台都需要以集装箱作为承载体。集装箱箱体标准由特种集装箱、特种集装箱箱体不遵循标准尺寸，根据用途和客户的具体需求，在结构方面进行了特殊设计和制造的集装箱。雅致集装箱有设备箱、仓储箱、非标物流箱以及其他。

雅致可提供以上所列的各种集装箱，更可为客户量身定做解决方案。产品的设计与制造符合国内外的相关认证标准，并通过各类型产品的检测，包括各种复杂的条件下集装箱使用情况的检测，以确保箱体在苛刻的自然环境下，满足客户设备、物品存储、特殊运输等用途。

Special Container is the custom made container which does not follow the international shipping container standard. Its structure and facilities are specially designed and made according to the purpose and the client's particular requirements. Yahgee could supply Equipment container, storage container, fuel tank container, workshop container, bulk cargo container, side opening container, open top container, Minus sets container, chemical container etc.

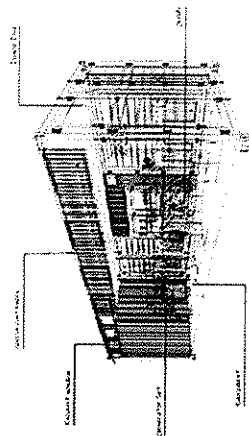

特种箱 SPECIAL CONTAINER

13 污水处理箱

Sewage treatment Container

污水处理箱是一种将污水处理装置集成于箱体中的特种集装箱，污水处理装置通过过滤器和消毒剂在废水排放管上，从而使生活污水达到排放标准或实现再次利用。

The sewage treatment container is a type of special container integrates the sewage treatment equipment. The sewage treatment equipment is to connect the filter and the sterilizer to drainage, to attain the disposal standard of waste water or water reuse.

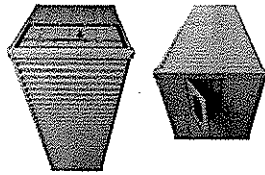

智能污水处理箱

Intelligent Sewage treatment Container

特种箱 SPECIAL CONTAINER

11 通讯设备箱

Data Communication Equipment Container

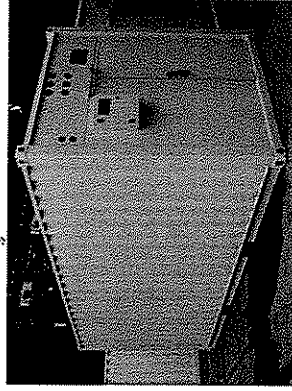
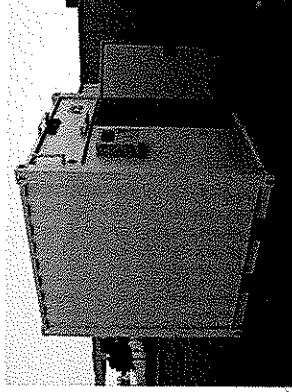

特种箱 SPECIAL CONTAINER

14 循环厕所箱

Circulating Toilet Container

循环厕所箱是一种污水循环系统，厕所排泄物经处理设备处理后，与输出化粪池人工孑尿便后所排，处理出来的水再循环利用，无需外加外部水源，同时没有污水排放，既降低了环境污染，又大大节约了水资源。

Recycle toilet container is a type of applications which integrates the sewage treatment system with the toilet fittings and fixtures, and other equipments into a container. There is no additional water supply feature for grey water disposal by the toilet system, thus to protect our environment and save our resources.

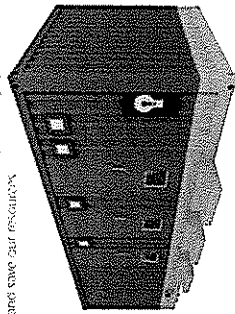

循环厕所箱

Circulating Toilet Container

特种箱 SPECIAL CONTAINER

12 储能设备箱

Energy storage equipment Container

储能设备箱是集成不间断电源、电池组、精密空调、温控装置等智能一体化的特种集装箱，符合环保要求，具有耐高温、消防阻燃功能，同时具备防雨、防尘、防震、防腐、防强磁等，满足各种应用环境。

The energy storage container is a type of integrated special containers, which consists of the uninterruptible power supply, battery pack, precision air conditioner, regulating system and other intelligent equipment. Environmental friendly with great performance of constant temperature, fire-proofing, water proofing, high-pressure, dust-proofing, lightning protection and etc., suitable for different situations.

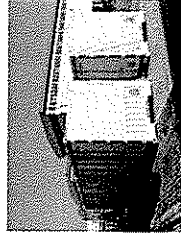
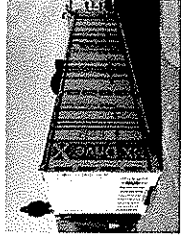
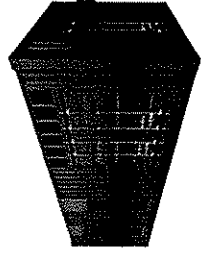

储能设备箱

Energy Storage Container

特种箱 SPECIAL CONTAINER

1.5 发电机组箱

Power Generator Container



雅致 YAHGEE

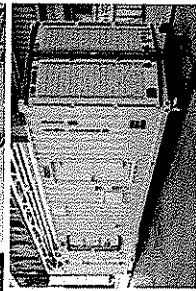
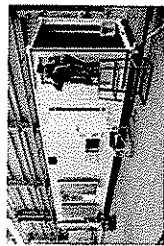

发电机静音箱
Power Generator Silent Container



1.5 发电机组
DT Generator Container

特种箱 SPECIAL CONTAINER

1.5 发电机组箱

Power Generator Container

发电机组由集装箱改装成发电机，形成可移动式电站，发电机功率设计容量从20吨至60吨，通过力学核算及承载实验，可满足大型机械设备的实验、运输、检修、通风等使用要求。

Power generator containers are containers integrated with power generators to form the mobile power stations. The design supporting capacity is between 20 tons and 60 tons. After several experiments to be carried out to ensure they are suitable for the installation, transportation, maintenance and ventilation of large generator facilities.

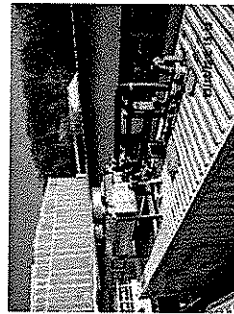
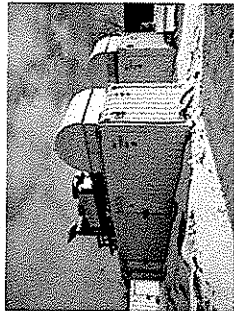

移动式发电机箱
Riviera Power Generator Container

特种箱 SPECIAL CONTAINER

1.5 发电机组箱

Power Generator Container



雅致 YAHGEE

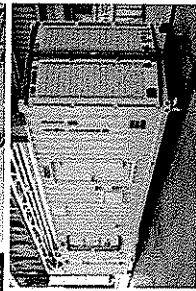
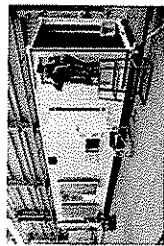

发电机静音箱
Power Generator Silent Container



1.5 发电机组
DT Generator Container

特种箱 SPECIAL CONTAINER

1.5 发电机组箱

Power Generator Container



雅致 YAHGEE

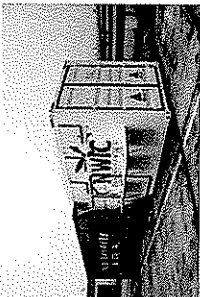
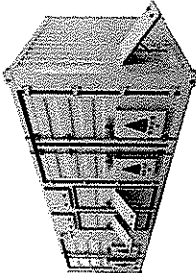

风力发电静音箱
Wind Power Test Container

特种箱 SPECIAL CONTAINER

1.5 发电机组箱

Power Generator Container

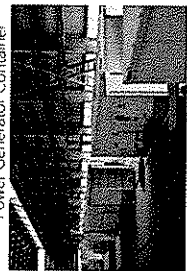

雅致 YAHGEE

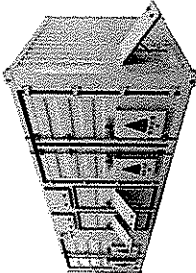

车力发电静音箱
L-Lower Power Generator Container

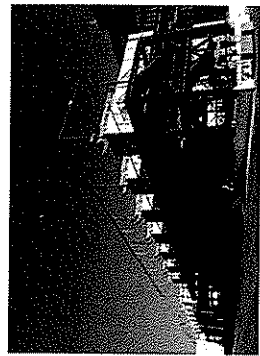

特种箱 SPECIAL CONTAINER

2.0 仓储箱
Storage Container



基本仓储箱
Basic Storage Container

特种箱 SPECIAL CONTAINER

2.0 仓储箱
Storage Container

仓储箱适用于户外存放各类物品，亦可作为报刊亭、小卖部、出租亭等使用。规格从10英尺到40英尺（3.048米到12.192米）不等，可根据客户需求进行个性化设计及内部装饰。

Storage containers are suitable for storing different types of goods, can also be used as the kiosk, kiosk others. etc. etc. Storage containers come in sizes 10-40 ft (3.048m to 12.192m), and customized design are available.

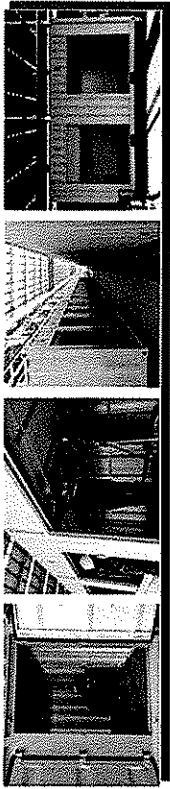

特种箱 SPECIAL CONTAINER

3.0 非标准物流箱
Non-standard Logistic Container

非标准物流箱不按标准集装箱国际标准尺寸，根据用途和客户的具体需求，在结构方面进行了特殊设计和制造。

The non-standard shipping containers are those do not follow the ISO standards, but designed and made according to the purpose and clients' requirements.

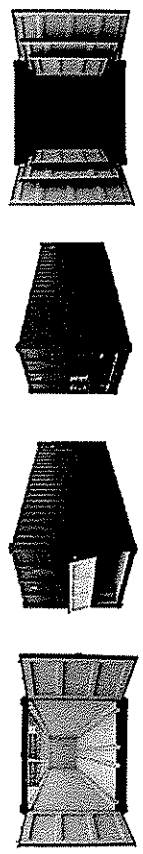

特种箱 SPECIAL CONTAINER

2.0 仓储箱
Storage Container

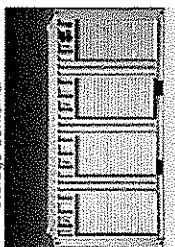

标准门式仓储箱
Standard Door Container

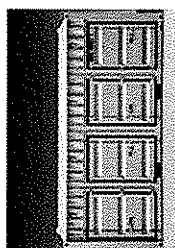

锁门式仓储箱
Locking Door Container

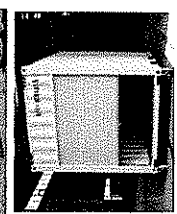
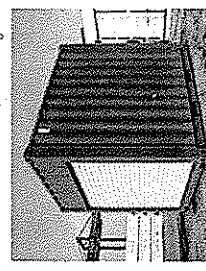

卷帘门式仓储箱
Roll-up Storage Container

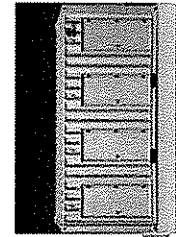

球顶门式仓储箱
Ball-top Door Container

特种箱 SPECIAL CONTAINER

3.3 平板柜箱 Platform Container

平板柜箱无顶部和侧壁，顶板可拆卸，只保留前和后板。通常从集装箱的前面进行装卸。适用于散装货物为主要运输对象。还可用于装载牲畜，以及诸如钢材之类可以免除外包装的货物。

This type of container has no top or side panels, and panels can be removed also with only bottom and 4 corner posts. Flatracks are especially suited to heavy loads or cargo that needs loading from the top or sides, such as livestock and steel these non-packaging goods.

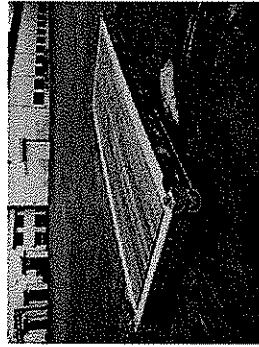

雅致
YAHGEE

特种箱 SPECIAL CONTAINER

3.1 迷你套箱 Mini Sets

迷你套箱的特点是可以将各种型号的产品叠放在一起，节约运费。1x20'=2x (10'+8'+6')
Mini container set is designed to insert the smaller containers into the larger ones for weight cost saving.
1x20'=2x (10'+8'+6')

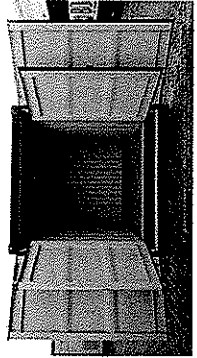
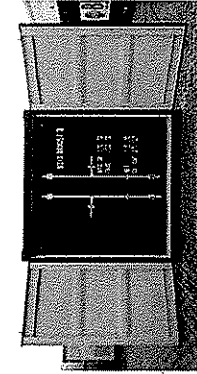

雅致
YAHGEE

特种箱 SPECIAL CONTAINER

3.4 散货箱 Bulk Container

散货箱是一种顶部可拆卸，也可以从顶部或侧面拆卸开盖的集装箱，适用于散装粉状或块状货物，如大豆、大米、各种饲料等。密封式箱体在顶部设有2至3个装货口，在箱门下部设有卸货口。

This type of container has no top or side panels and panels can be removed also with only bottom and 4 corner posts. Flatracks are especially suited to heavy loads or cargo that needs marking from the top or sides, such as livestock, and steel these non-packaging goods.

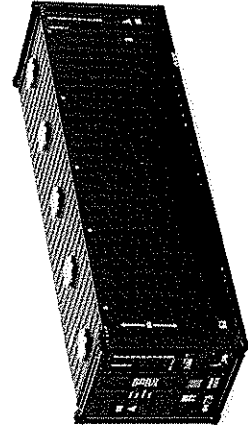

雅致
YAHGEE

特种箱 SPECIAL CONTAINER

3.2 侧开门箱 Side Opening Container

侧开门箱具有较强的定制性，可根据货物的不同定制门的尺寸和位置，以便货物的装卸。
The opening size and position of open-side containers can be customized for easy loading of heavy machinery or oversized pallets.

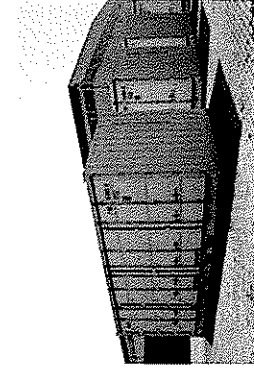
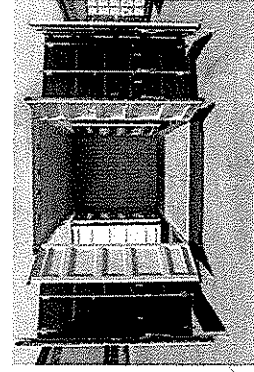

雅致
YAHGEE

产品特点 PRODUCT FEATURES

预制化程度高，现场施工周期短 Highly prefabricated, short construction period

模块化生产，工厂预制，现场拼装，施工周期短，质量高，可快速交付使用。适用于各种建筑，如学校、酒店、公寓、办公室、临时住所等。模块化生产，工厂预制，现场拼装，施工周期短，质量高，可快速交付使用。适用于各种建筑，如学校、酒店、公寓、办公室、临时住所等。

模块化流水线生产，质量高度可控 Line production, high quality control

模块化生产，工厂预制，现场拼装，施工周期短，质量高，可快速交付使用。适用于各种建筑，如学校、酒店、公寓、办公室、临时住所等。模块化生产，工厂预制，现场拼装，施工周期短，质量高，可快速交付使用。适用于各种建筑，如学校、酒店、公寓、办公室、临时住所等。

单元模块化功能强，适用范围广 Various module sizes, wide usages

模块化生产，工厂预制，现场拼装，施工周期短，质量高，可快速交付使用。适用于各种建筑，如学校、酒店、公寓、办公室、临时住所等。模块化生产，工厂预制，现场拼装，施工周期短，质量高，可快速交付使用。适用于各种建筑，如学校、酒店、公寓、办公室、临时住所等。

安全性能高，耐久性强 High safety performance, durable life time

模块化生产，工厂预制，现场拼装，施工周期短，质量高，可快速交付使用。适用于各种建筑，如学校、酒店、公寓、办公室、临时住所等。模块化生产，工厂预制，现场拼装，施工周期短，质量高，可快速交付使用。适用于各种建筑，如学校、酒店、公寓、办公室、临时住所等。

组合多样化，宜居性能佳 Various combinations, great livability

模块化生产，工厂预制，现场拼装，施工周期短，质量高，可快速交付使用。适用于各种建筑，如学校、酒店、公寓、办公室、临时住所等。模块化生产，工厂预制，现场拼装，施工周期短，质量高，可快速交付使用。适用于各种建筑，如学校、酒店、公寓、办公室、临时住所等。

可循环利用，拆装移动便捷 Recyclable, easy for transporting and assembling

模块化生产，工厂预制，现场拼装，施工周期短，质量高，可快速交付使用。适用于各种建筑，如学校、酒店、公寓、办公室、临时住所等。模块化生产，工厂预制，现场拼装，施工周期短，质量高，可快速交付使用。适用于各种建筑，如学校、酒店、公寓、办公室、临时住所等。

雅致 YAHGEE



模方空间

TETRIS SPACE

1 预制化程度高，现场施工周期短 Highly prefabricated, short construction period

2 模块化流水线生产，质量高度可控 Line production, high quality control

3 单元模块尺寸多样，适用范围广 Various module sizes, wide usages

4 安全性能高，耐久性强 High safety performance, durable life time

5 组合多样化，宜居性能佳 Various combinations, great livability

6 可循环利用，拆装移动便捷 Recyclable, easy for transporting and assembling



模方空间-内部装饰 TETRIS SPACE - Internal Decoration

三明治板 Sandwich Panels



石膏板 Gypsum Board



铝塑板 Alu-plastic Board



模方空间 TETRIS SPACE

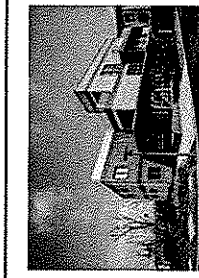

雅致 YAHGEE

模方空间可应用于许多理想建筑，它们由海运集装箱的理念应运而生，抗压强，可堆叠数层，更好的抵御恶劣环境威胁。其广泛应用于别墅、酒店、学生公寓、营地等。
TETRIS SPACE is in many ways an ideal building. They are designed from shipping containers, which carry heavy loads and to be stacked in high columns. They can also be designed to resist harsh environments. They are widely used as villa, hotel, student accommodation, camp etc.

模方空间-经典案例 TETRIS SPACE - TYPICAL PROJECTS

澳大利亚珀斯-Tribe酒店
Tribe Hotel, Perth, Australia

- 位于澳大利亚珀斯
Perth, Australia
- 共4楼, 63个房间组成
4 story with 63 modules
- 一楼二楼的钢结构与玻璃
1st & 2nd floor is constructed by steel
- glass frame structure
- 工厂定制3%的内部装饰
3% internal finishes
completed in factory
- 如期完工, 无停工
MS Daily and Return of the
rental

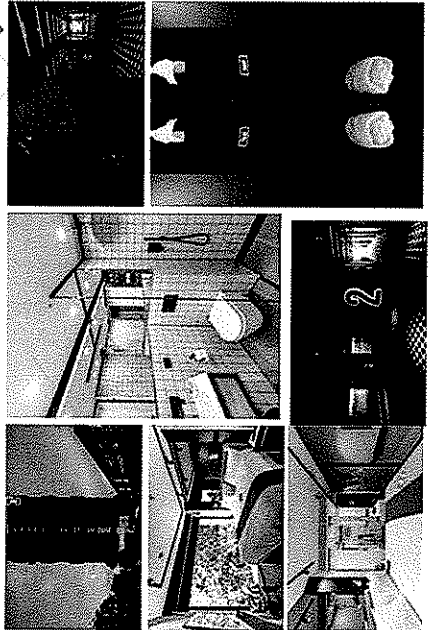

雅致 YAHGEE

模方空间-典型单元尺寸 TETRIS SPACE - Typical Accommodation Units

- 推荐尺寸, 易于运输
Recommend dimension for better transportation
- 1) 6058(20' . 1) x 2438(8' . 0) x 2896(9' 6" . 1) mm;
- 2) 12192(40' . 1) x 2438(8' . 0) x 2896(9' 6" . 1) mm

- 对于特殊项目, 工厂最长可以做到16米多长, 4.6米宽, 3.3米高。
For some special projects, super container house with 16.154mm long, 4.620mm wide and 3.300mm high

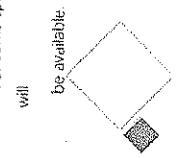

模方空间-经典案例 TETRIS SPACE - TYPICAL PROJECTS





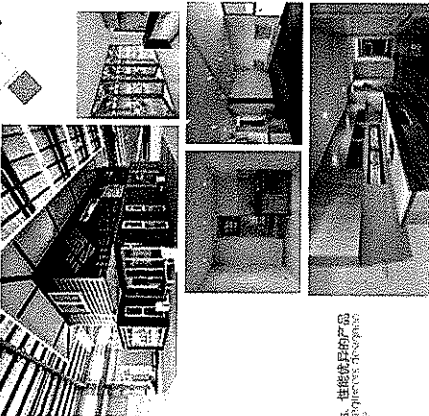











新西兰别墅
New Zealand Villa

- 雅致设计团队定制方案
5 total, villa designed by Yahgee
- 用于新西兰多个地点
At New Zealand various locations
- 轻奢混搭风格
luxury design with interior to Grade 5+
- 结合地质, 环境, 生活习惯等因素, 提供整体产品
Considering geology, environment, local basis, air, noise and equipment, we provide a series of products with flexible combination and excellent performance



雅致 YAHGEE





模方空间-完工案例 TETRIS SPACE - COMPLETE PROJECTS

2018	2017	2016	2015
 Norway Apartment 公寓公寓	 Australia Sky Resort 度假休闲区	 Singapore JTC Center 工厂加工区	 New York City 白领公寓
 Vietnam Camp 营地	 Australia Victorian Center 购物中心	 New Zealand 新西兰度假公寓	 Singapore 新加坡
 Vietnam 越南	 Australia 澳大利亚	 New Zealand 新西兰	 Singapore 新加坡
 New York City 纽约	 Australia 澳大利亚	 New Zealand 新西兰	 Singapore 新加坡

模方空间-经典案例 TETRIS SPACE -- TYPICAL PROJECTS

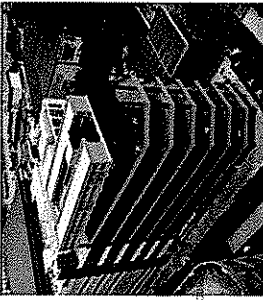
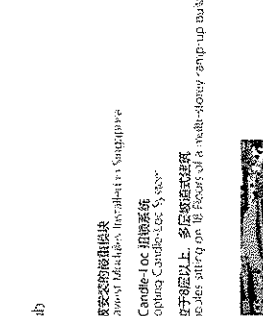
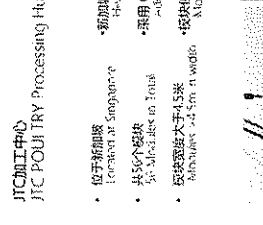
JTC加工中心
JTC POLYTRY Processing Hub

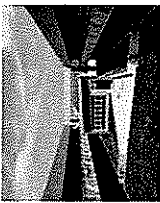
- 位于新加坡
Location in Singapore
- 共50个模块
50 Modules
- 模块宽度大于4.5米
Modules > 4.5m in width
- 新加坡最大的预制模块
Largest Modular Installation in Singapore
- 采用 Candle-Loc 扣锁系统
Adopting Candle-Loc System
- 模块位于楼层以上, 多已就位或正在安装
Modules sitting on 10 floors of the multi-storey strip-up building











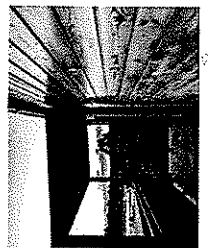

模方空间-经典案例 TETRIS SPACE -- TYPICAL PROJECTS

挪威-模块化公寓小区
Modular Residential Villages, Norway

- 地点: 挪威
Location: Norway
- 体积: 24 x 40' HC modules
Volume: 24 x 40' HC modules
- 项目描述: 本项目共分四个阶段, 目前, 完成的一期工程由2套公寓和2个单元组成, 每个单元由2个模块组成, 包括客厅、卧室、浴室、厨房、餐厅等, 这四个阶段完成后可容纳300到500人。



Description:
There are total 4 stages of this project.
Currently, finished stage 1 consists of 2 apartments by 2 units. Every apartment is composed by 2 modules, including living room, bedroom, bathroom, kitchen, living room and etc. All 4 stages could occupy 300 to 500 people.

模方空间-经典案例 TETRIS SPACE -- TYPICAL PROJECTS

综合医院及高级护理中心
Development of Polyclinic, Nursing Home & Senior Care Centre at Woodlands Road

- 位于新加坡
Project in Singapore
- 共488个模块, 83个屋顶模块
488 Modules with 83 Roof Modules in Total
- 总面积: 8,000 平方米
Total Floor Area: 8,000 sqm
- 采用 Candle-Loc 扣锁系统
Adopting Candle-Loc System
- 工厂制作
Under Fabrication in the Factory

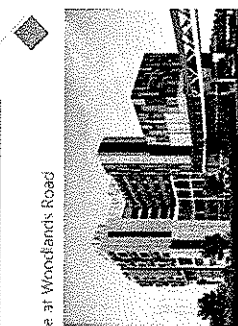
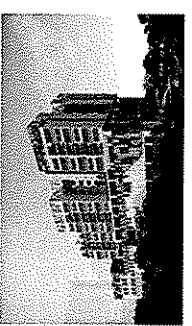
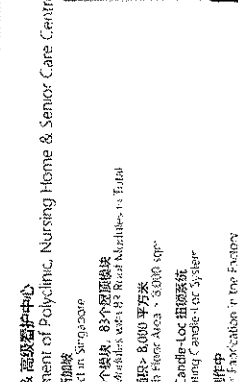
模方空间-经典案例 TETRIS SPACE -- TYPICAL PROJECTS

墨尔本公寓-澳大利亚天空度假村
Melbourne Apartment - Australia at Sky Resort

- 位于墨尔本郊区的青山
Located at Green Mountains at Melbourne
- 具有非常好的隔热性能及隔音效果
High-end modules with Good Thermal insulation
- 在山上建设公寓, 无变形
Transported and installed at steep mountains without Deformation
- 建于非传统建筑
Built during Non-Traditional

模方空间-经典案例 TETRIS SPACE - TYPICAL PROJECTS

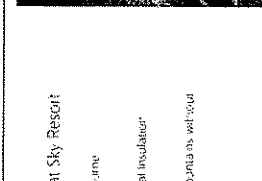
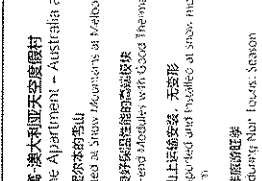
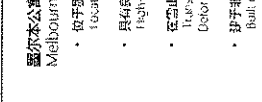
江苏南京中心三瓦模块化基地项目
Sanya Modular Project

- 位于三亚
Located in Sanya China
- 含多间会议室、茶室、餐厅、住宿等多功能
Multiple conference room, accommodation, meeting room, dining room, accomodation room etc.
- 响应速度快，绿色建造，第一个模块化建筑项目
In response to BFA, Green Habitat, this project is the first modular project in China
- 95%工厂预制，后期现场拼装
>95% of MEP & Interior Decoration works completed in Factory, great installation performance

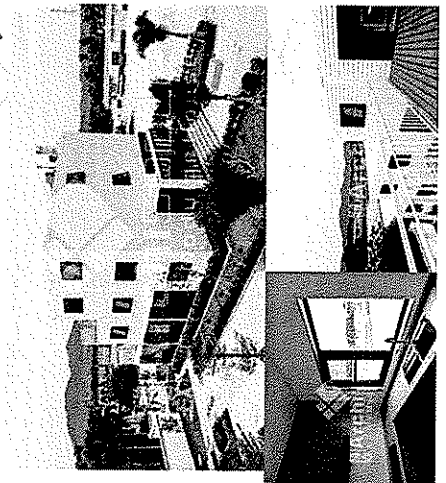

模方空间-经典案例 TETRIS SPACE - TYPICAL PROJECTS

日本旅游旅馆
Japan Tourist Motel

- 地点：富士山
Location: Fuji Mountain
- 体积：50 x 20' HC
Volume: 50 x 20' HC modules
- 项目介绍：与日本设计协会合作，定制提供50个单元的模块化集装箱建筑20个单元，在静冈县地区。
Description: Cooperated with Japan Designer, Yanspe supplied total 50 units modular container which composed 20 sets metal fabric

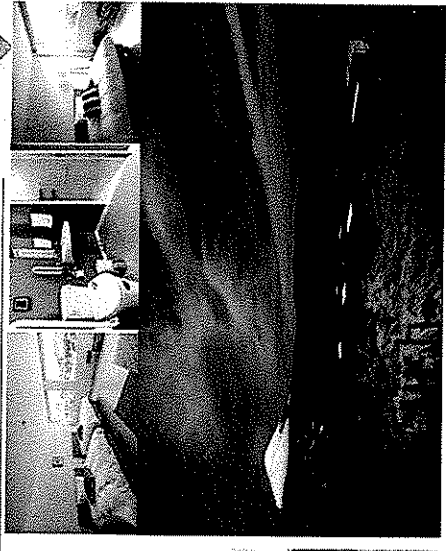

模方空间-经典案例 TETRIS SPACE - TYPICAL PROJECTS

黄山齐云景区
Mount Qiyun Park Huangshan

- 地点：中国，黄山
Location: Huangshan, Anhui, China
- 体积：122 模块
Volume: 122 modules
- 项目介绍：它并非普通大众休闲度假公园，包括商业街、餐饮、娱乐、水上乐园等。入口设计非常独特，每个模块作为一个单元，空余化模块衔接不同的方向，强调工作重心为提供稳定的运营性能的工作。"
Description: It's the "unique outdoor sports and leisure park in China". It includes shopping street, catering, entertainment, water activity and etc. Entrance design is quite hard to suit every 6' modules, as one group at least 16 of them are pushing 120' length direction. The assembly work is a challenge at first, it's the most challenging ones in the history of modules construction.

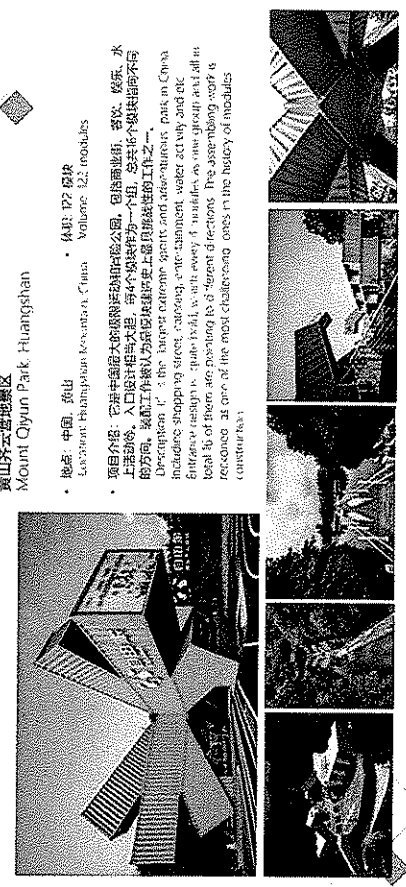

模方空间-经典案例 TETRIS SPACE - TYPICAL PROJECTS

挪威公寓项目
Norway Apartment

- 位于挪威
Located in Norway
- 5套模块化建筑，每个模块
3 sets of mod 20' high and 16'4" Modules in Total
- >95% 预制及安装在工厂内完成
More than 95% of MEP & Interior Decoration works completed in Factory
- 保证效果良好及低耗电
Low Energy Consumption

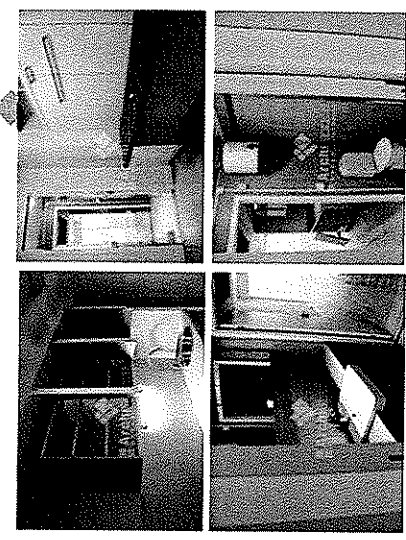

模方空间-经典案例 TETRIS SPACE - TYPICAL PROJECTS

雅致 YAHGEE

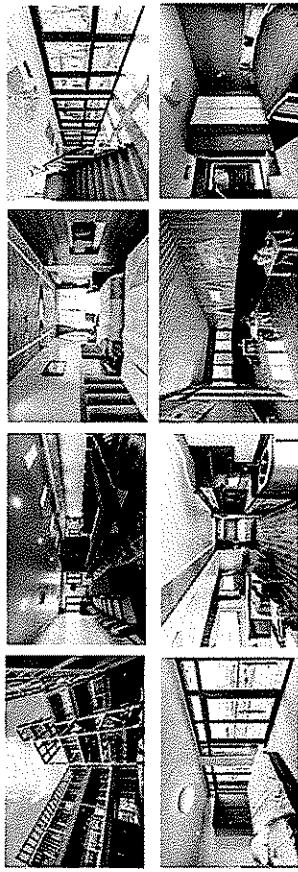

模方空间-经典案例 TETRIS SPACE - TYPICAL PROJECTS

雅致 YAHGEE

咸宁市蒙山湖蒙方模块酒店
Honeyymoon Modular Hotel, Zishan Lake,
Xianning

- 体积: 257个模块
Volume: 27 modules
- 占地面积: 8,800m²
Building Area: 8,800m²
- 功能: 接待、酒店客房、餐厅
Function: Reception, hotel rooms, buffet
- 项目描述: 作为世界上最大的预制模块化酒店基地, 由32栋每栋2层酒店模块组成。标准间由厨房、浴室和卧室组成。标准8单元的32栋酒店模块。每个模块包含: 客房、浴室、餐厅、会议室和接待区。

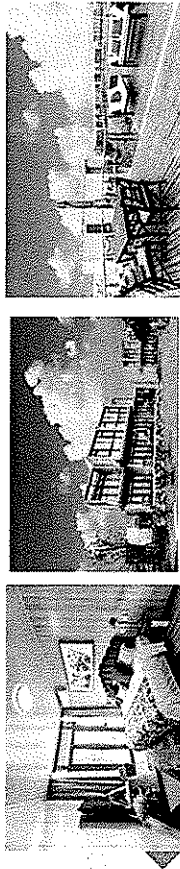
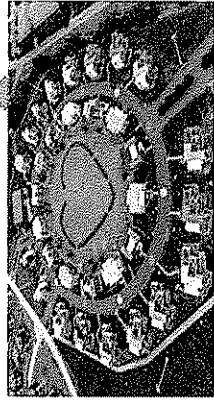

打包箱

FLAT-PACK

雅致 YAHGEE

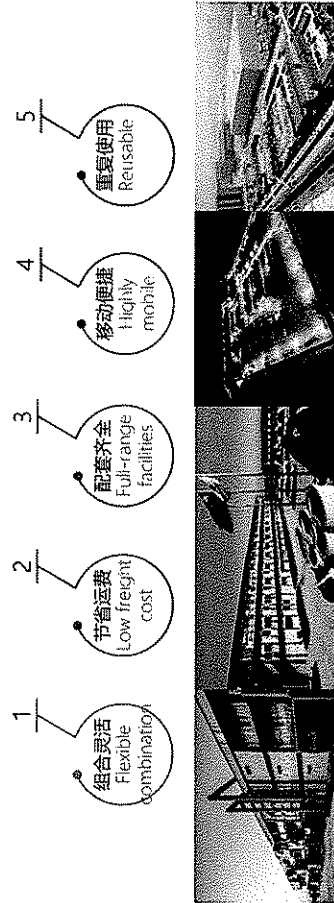

模方空间-经典案例 TETRIS SPACE - TYPICAL PROJECTS

雅致 YAHGEE

绿博馆

Green Building Expo
地点: 江苏, 常州
Location: Jiangsu, Wuxi
• 体积: 59个模块
Volume: 59 modules

- 项目描述: 该中心旨在积极响应国家绿色建筑发展的号召, 及绿色生态建筑理念。总建筑面积2161平方米, 一楼为生态体验馆, 二楼为生态展示厅, 三楼为生态展示厅, 四楼为生态展示厅, 五楼为生态展示厅。该中心由32个模块组成, 每个模块包含: 客房、浴室、餐厅、会议室和接待区。

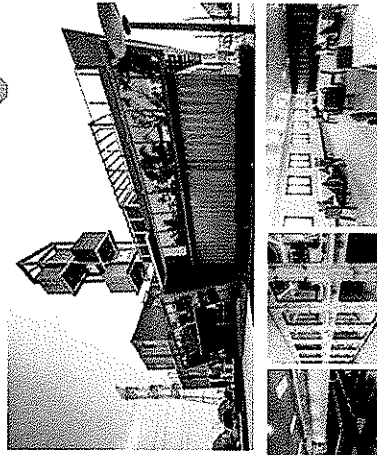

打包箱-典型单元-住宿

FLAT-PACK-Typical Modular Unit-Accommodation

雅致 YAHGEE

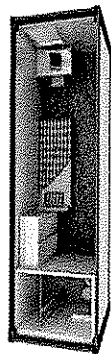

6058(L) x 2438(W)mm - 单人房 One Person

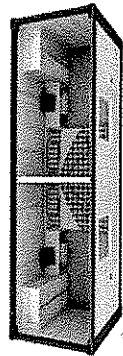

6058(L) x 2438(W)mm - 两人房 Two Person



6058(L) x 2438(W)mm - 两人房 Two Person

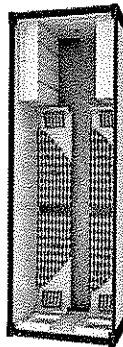

6058(L) x 3022(W)mm - 四人房 Four Person

产品介绍 PRODUCT INTRODUCTION

雅致 YAHGEE

雅致打包箱是一种创新的住宿解决方案，旨在为建筑工地、临时办公室、培训中心等提供快速部署和灵活的空间。其设计紧凑，易于运输和安装，可轻松适应各种环境。每个单元都配备了基本的生活设施，如床铺、桌椅、照明和通风系统，确保居住者能够舒适地工作和生活。此外，雅致打包箱还具有防火、防水和防虫咬等特性，为居住者提供安全可靠的保障。

Yahgee Flat pack house is a prefabricated modular unit that offers a cost-effective and flexible accommodation solution for temporary office, training center, and other locations. The design is compact and easy to transport and install, making it suitable for various environments. Each unit is equipped with basic living facilities such as beds, desks, lighting, and ventilation systems, ensuring a comfortable living and working environment. Additionally, the units feature fireproof, waterproof, and insect-proof properties, providing a safe and reliable living space.

Each unit could be packed and shipped as 40' HQ, etc. 2' amb, which will reduce the shipping cost much.

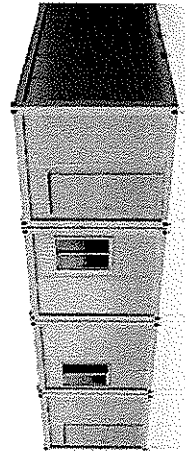

组件 Components



打包箱单元 Single Unit



打包箱单元 Combined Units



打包箱单元 (2个单元位) In Line Configuration 2 x 20' Pack



打包箱单元 (2个单元位) In Line Configuration 2 x 40' Pack

打包箱-典型单元-卫浴

FLAT-PACK-Typical Modular Unit - Toilet, Shower and Bathroom

雅致 YAHGEE



6058(L) x 2438(W)mm - 男卫生间 Toilet - Male

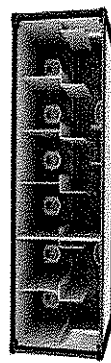

6058(L) x 2438(W)mm - 女卫生间 Toilet - Female

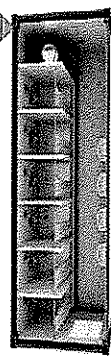

6058(L) x 2438(W)mm - 淋浴间 Shower room



6058(L) x 2438(W)mm - 卫生间 Bathroom

打包箱-典型单元-办公室

FLAT-PACK-Typical Modular Unit-Office

雅致 YAHGEE

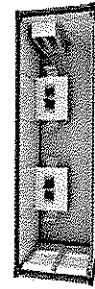

单箱 Single unit



拼箱 Combined units

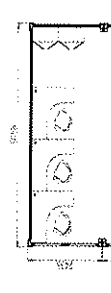

产品介绍 - 典型装运过程
PRODUCT INTRODUCTION - TYPICAL DELIVERY PROCEDURE

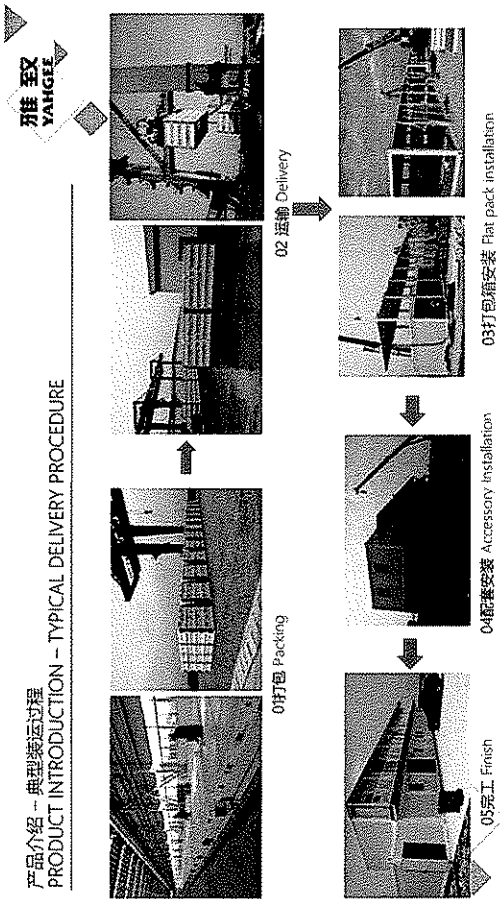

打包箱-材料和附件
FLAT-PACK- Materials and Accessories

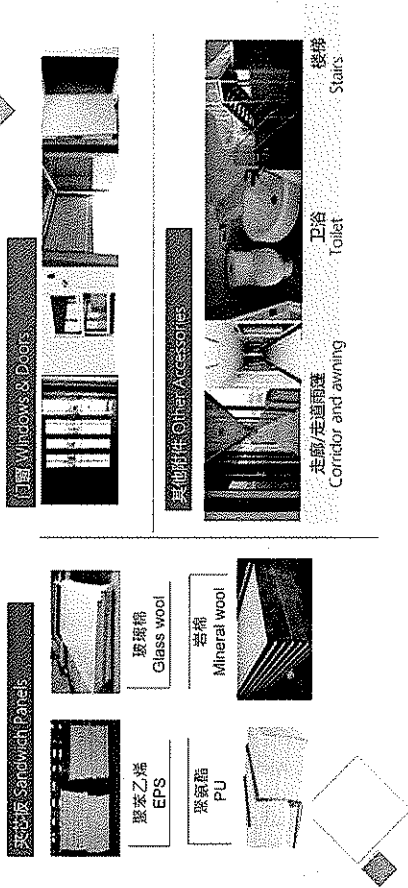

打包箱案例——海外营地项目
FLAT-PACK PROJECTS——Oversea Camp Project

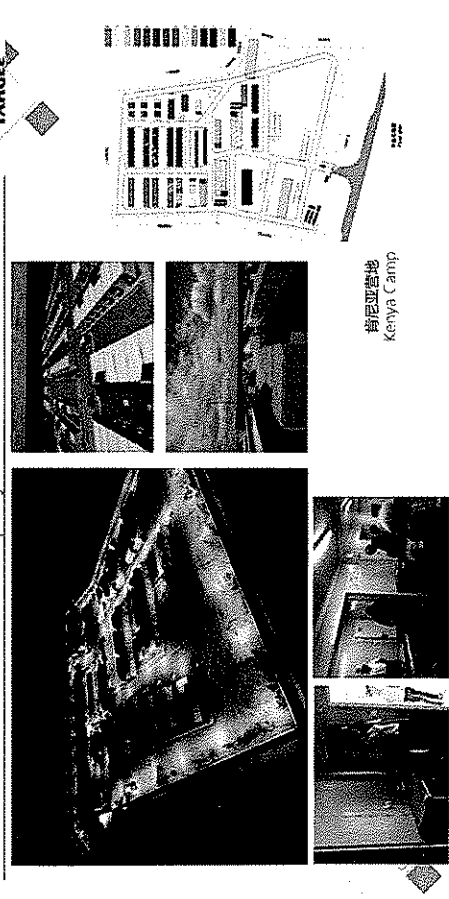

打包箱-典型配套
FLAT-PACK- TYPICAL ACCESSORY

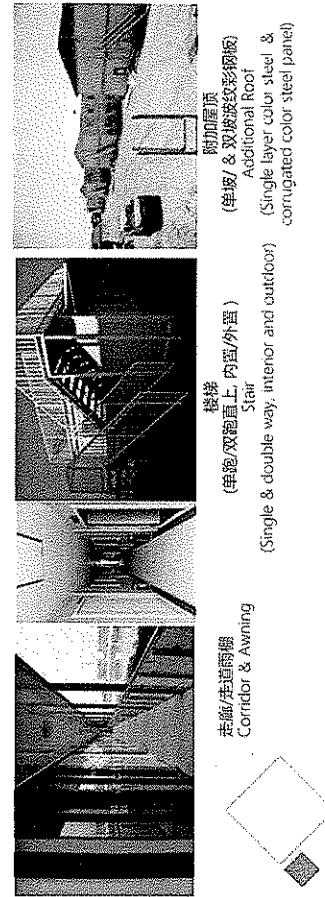

雅致
YAHGEE

打包箱案例——海外营地项目
FLAT-PACK PROJECTS——Oversea Camp Project

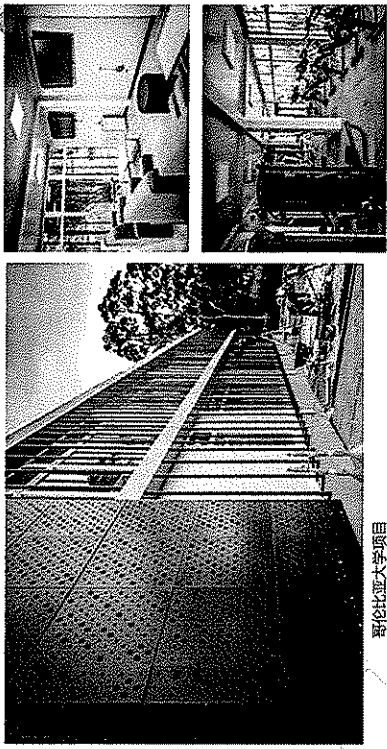

哥伦比亚大学项目
Columbia University Program

雅致
YAHGEE

打包箱案例——海外营地项目
FLAT-PACK PROJECTS——Oversea Camp Project

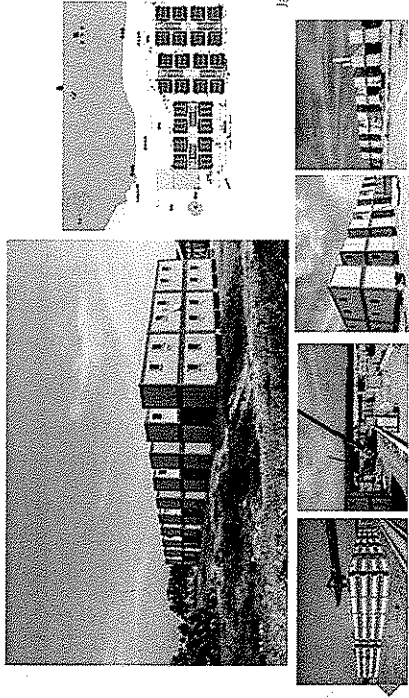

日本福岛重建营地
Japanese Earthquake Relief

雅致
YAHGEE

打包箱案例——海外营地项目
FLAT-PACK PROJECTS——Oversea Camp Project

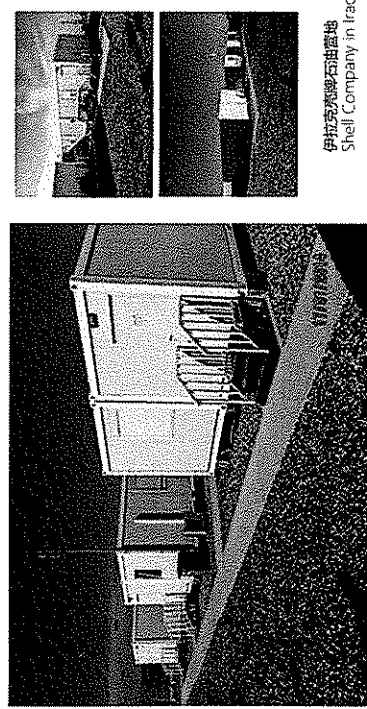

伊拉克壳牌石油营地
Shell Company in Iraq

雅致
YAHGEE

打包箱案例——海外营地项目
FLAT-PACK PROJECTS——Oversea Camp Project



阿根廷大坝营地
Argentina Dam Camp

打包箱案例——国内营地项目
FLAT-PACK PROJECTS——Domestic Camp Project

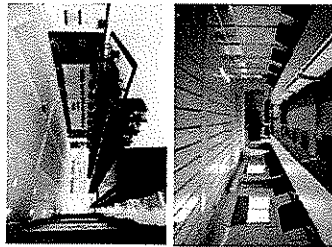
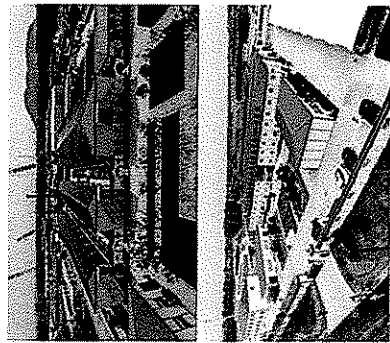

中铁十四局济黄河隧道工程EPC项目营地
China Railway 14th Bureau Jnan Yellow River
Tunnel EPC project

雅致
YAHGEE

打包箱案例——海外营地项目
FLAT-PACK PROJECTS——Oversea Camp Project

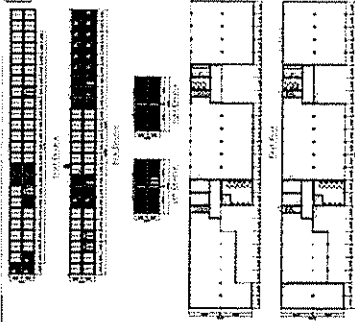
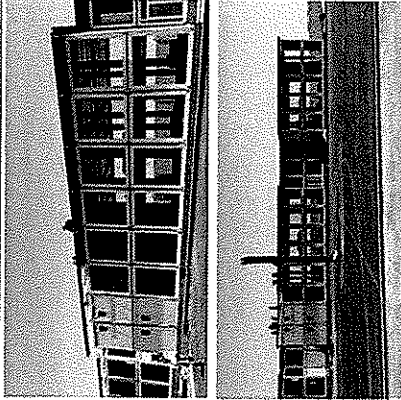

中东军用营地
Middle East Military Camp

雅致
YAHGEE

打包箱案例——国内营地项目
FLAT-PACK PROJECTS——Domestic Camp Project

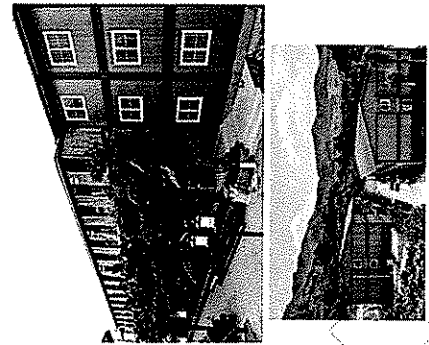

中铁十四局三亚红色娘子军项目营地
China Railway 14 Bureau Group
Sanya Women's Red Detachment Project

雅致
YAHGEE

打包箱案例——海外营地项目
FLAT-PACK PROJECTS——Oversea Camp Project

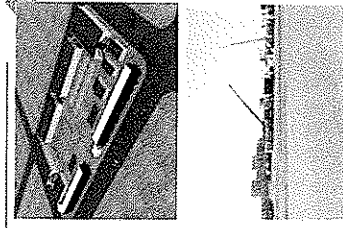
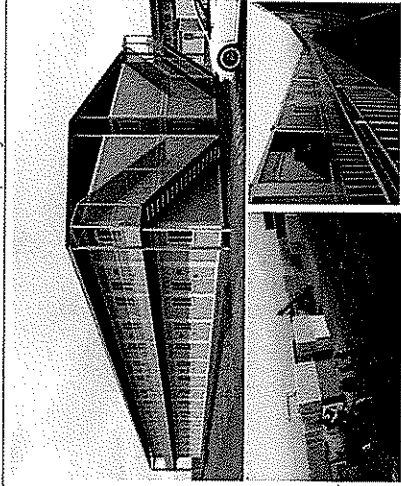

中东1000人劳改营地
Middle East: 1000 person Labor Camp

雅致
YAHGEE

打包箱案例——国内营地项目
FLAT-PACK PROJECTS——Domestic Camp Project

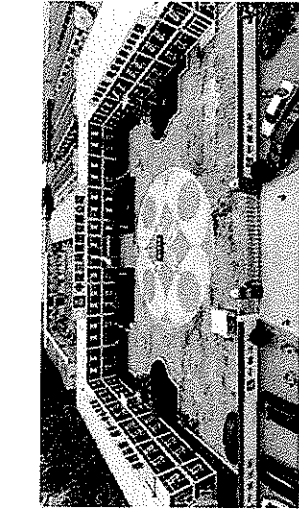

中建三局天津市第一中心医院新址扩建项目
China Construction Third Bureau
Tianjin the First Center Hospital New Site Expansion Project

雅致
YAHGEE

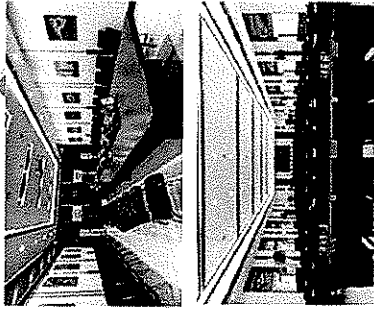

打包箱案例——国内营地项目
FLAT-PACK PROJECTS——Domestic Camp Project

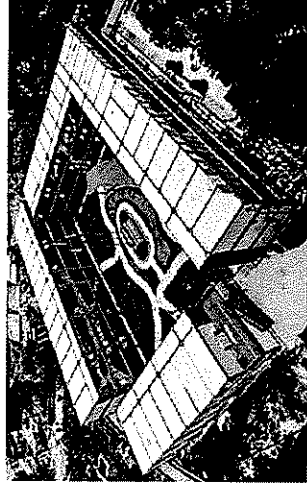

中建三局广州南沙少年宫项目营地
China Construction Third Bureau
Guangzhou Nansha Children's Palace Project

雅致
YAHGEE

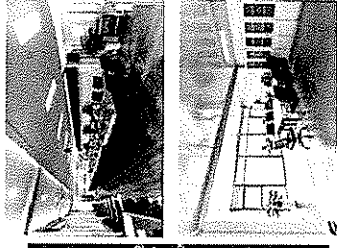

打包箱案例——国内营地项目
FLAT-PACK PROJECTS——Domestic Camp Project

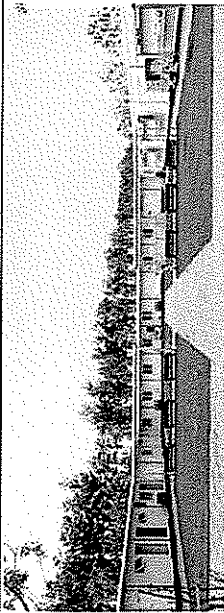

雄安新区建设者生活服务中心项目营地
Xiongan New Area Builder Life
Service Center Project

雅致
YAHGEE



打包箱案例——国内营地项目
FLAT-PACK PROJECTS——Domestic Camp Project

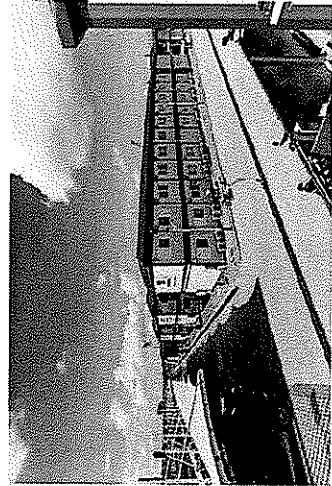

中建深圳国际会议中心项目营地
China Construction
Shenzhen International Exhibition Center

雅致
YAHGEE

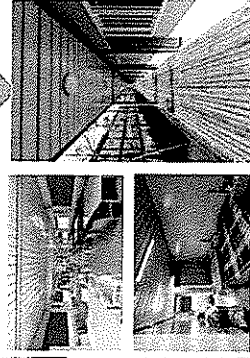

打包箱案例——国内营地项目
FLAT-PACK PROJECTS——Domestic Camp Project



海关行政大楼
Administration Building for Customs Office

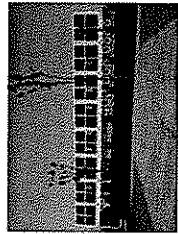
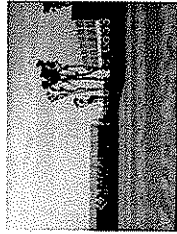

雅致
YAHGEE

打包箱案例——国内营地项目
FLAT-PACK PROJECTS——Domestic Camp Project

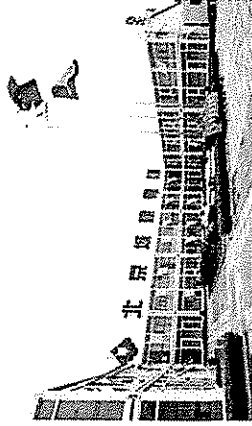
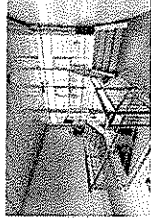

北京新机场工作区工程 (市政交通) 道桥及管网工程5标段项目营地
Beijing New Airport Working Area Project (Municipal Traffic) Highway Bridge & Pipe Network Project 5

雅致
YAHGEE



打包箱案例——国内营地项目
FLAT-PACK PROJECTS——Domestic Camp Project



雅致酒店
YAHGEE Hotel

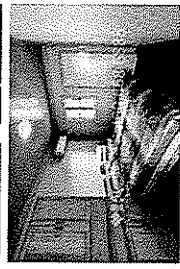
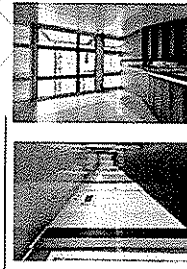

雅致
YAHGEE

打包箱案例——国内营地项目
FLAT-PACK PROJECTS——Domestic Camp Project

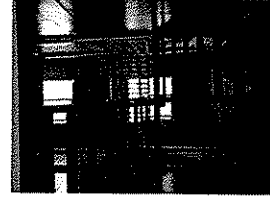
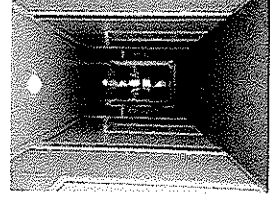
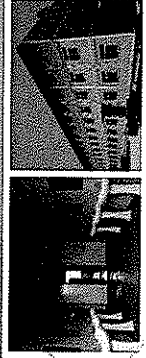
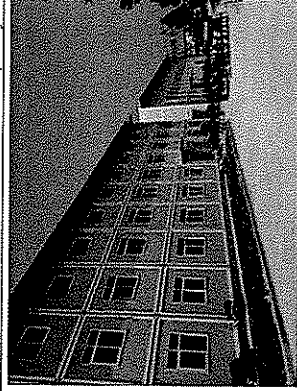

军事夏令营项目营地
Military Camp Project



TIANJIN ARCHITECTURE DESIGN INSTITUTE
天津市建筑设计院

医疗全产业链服务模式

Medical architecture all-round service model

TIANJIN ARCHITECTURE DESIGN INSTITUTE MEDICAL ARCHITECTURE DESIGN INSTITUTE
天津市建筑设计院 医疗设计院

Creating A Service Mode of the Medical architecture
all-round service Led by Intelligent Medical

Tianjin Architecture
Design Institute



Sci-tech enterprise
group providing
integrated service to
customers

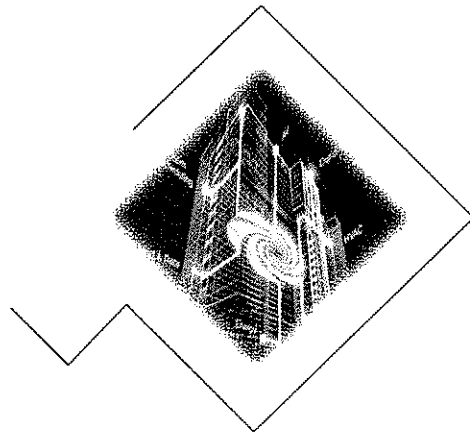

Healthcare
Design
Institute



Smart medical
treatment leaders
promote leapfrog
development of
healthcare industry

STRATEGIC PARTNER

ABOUT US

Tianjin Architecture Design Institute (TADI) was founded in 1952, which has developed into the largest comprehensive architecture design unit with strong technical strength and a galaxy of talents in Tianjin. There are more than 1,300 employees, including 3 national engineering design masters, 11 experts who enjoy special government allowances approved by the State Council, 5 Tianjin survey and design masters and over 300 registered staffs of all kinds access to national-level certification.

The Healthcare Design Institute subordinate to TADI, aims at 'Creating a service mode of the entire healthcare industry chain led by smart healthcare', with business sectors of designing, consulting, PPP, EPC, smart operation and maintenance management based on integration and in accordance with smart healthcare concept and the long-term finance lease of healthcare devices under the smart control, as well as other types of business services of the hospital.

Rank among the forefront of domestic first-class academy and achieve five first-class goals

- Technology Quality
- Design Brand
- Enterprise Culture
- Talent Team
- Economic Benefit

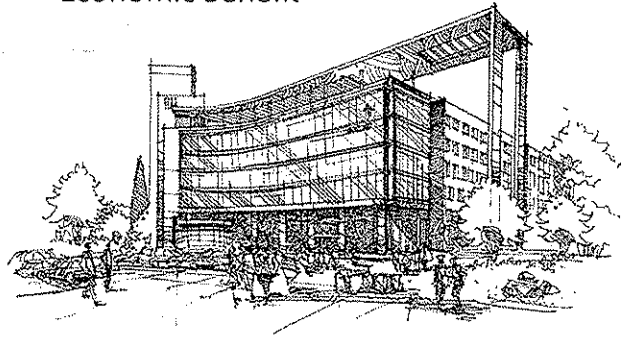

COMPANY QUALIFICATION



企业法人营业执照



建筑甲级/风景园林甲级



城乡规划甲级

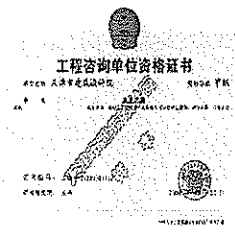

工程咨询甲级



国际咨询工程师联合会
成员协会会员

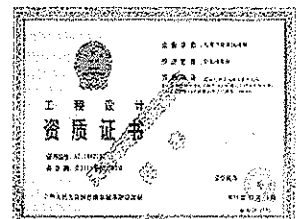

人防工程乙级



长城质量管理体系认证



深基坑支护工程专项

ORGANIZATION STRUCTURE

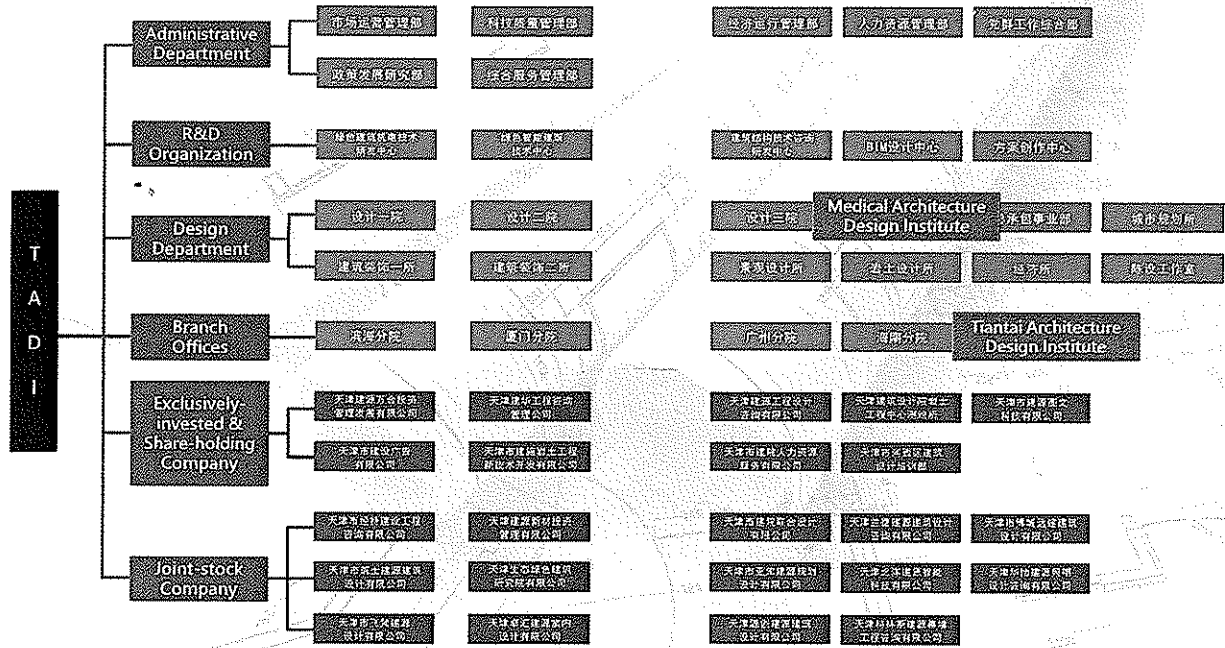

ABOUT US

智慧医疗
Intelligent Medical

全产业链服务链
Medical architecture
all-round service model

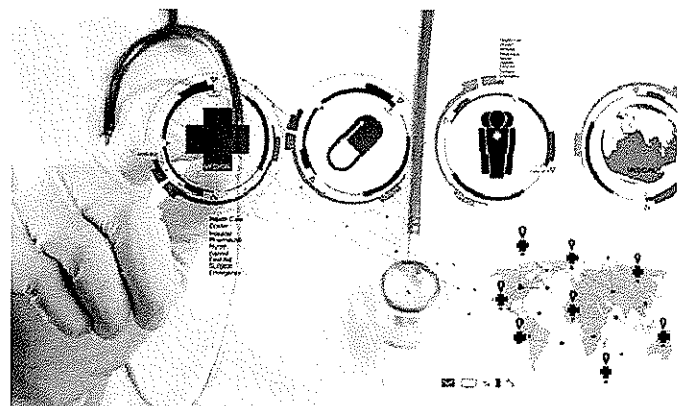

Sci-tech Enterprise Group Providing Integrated Service to Customers



ABOUT BUSINESS

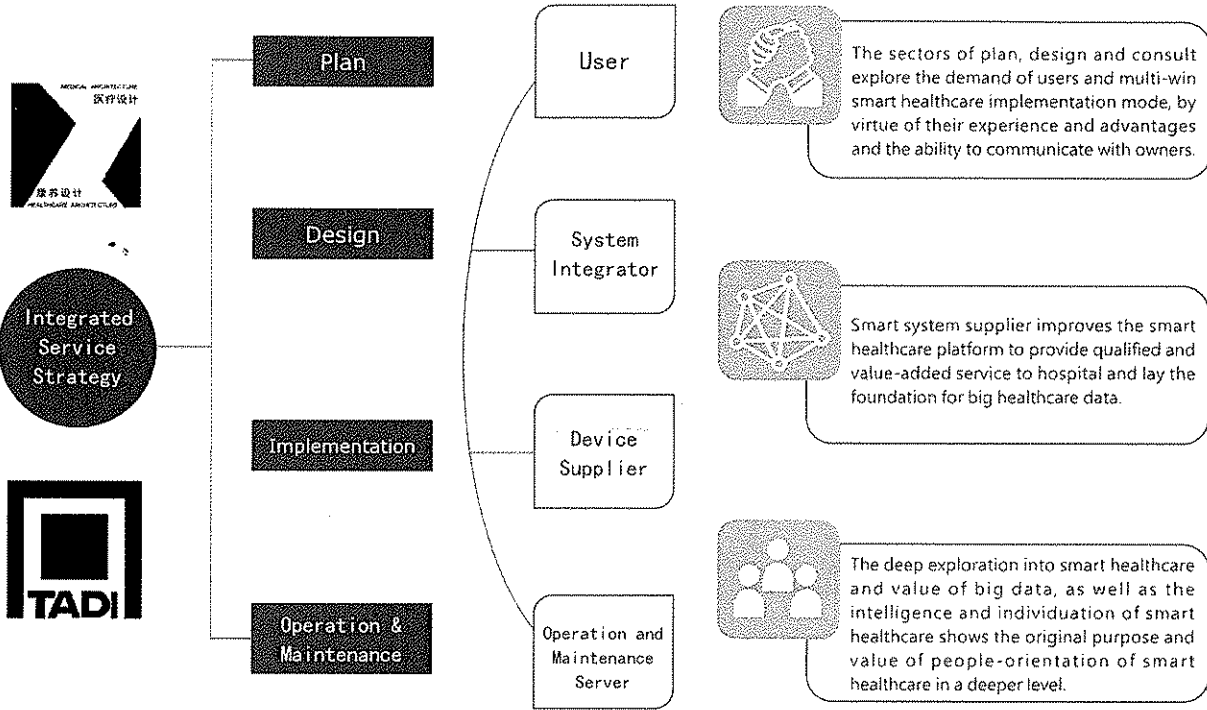

The first enterprise provides the integration design of healthcare and architecture at the same time and achieves the whole eco-friendly process in project construction.



ABOUT BUSINESS

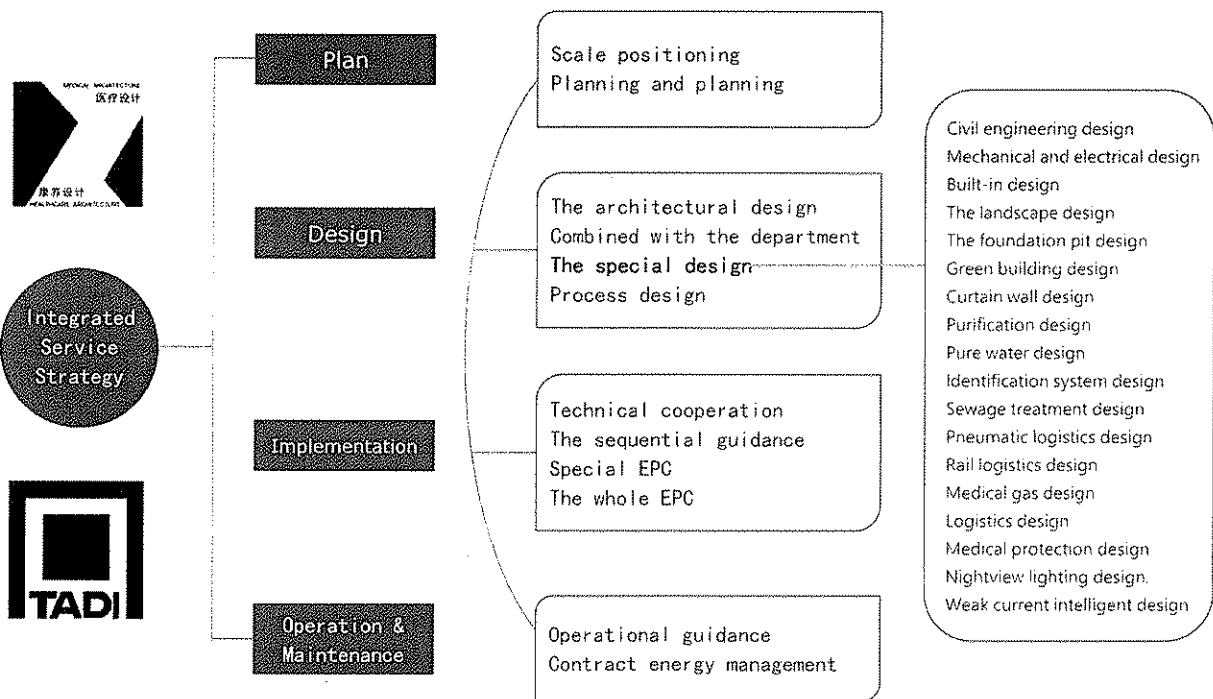

The first enterprise provides the integration design of healthcare and architecture at the same time and achieves the whole eco-friendly process in project construction.



Civil engineering, electromechanical, landscape and green building planning: rational planning and layout, making full use of building roofing and environmental landscape resources, and closely combining mechanical and electrical design to achieve the green building two stars and meet the sponge city indicators.

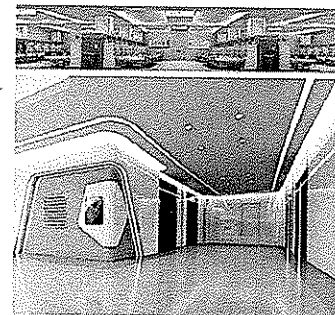
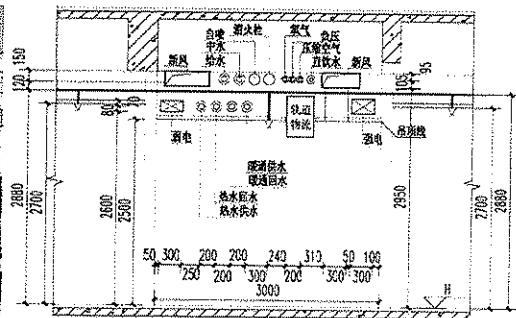
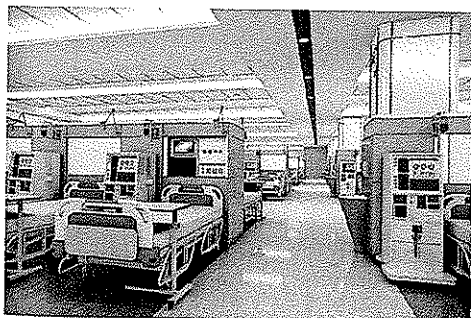
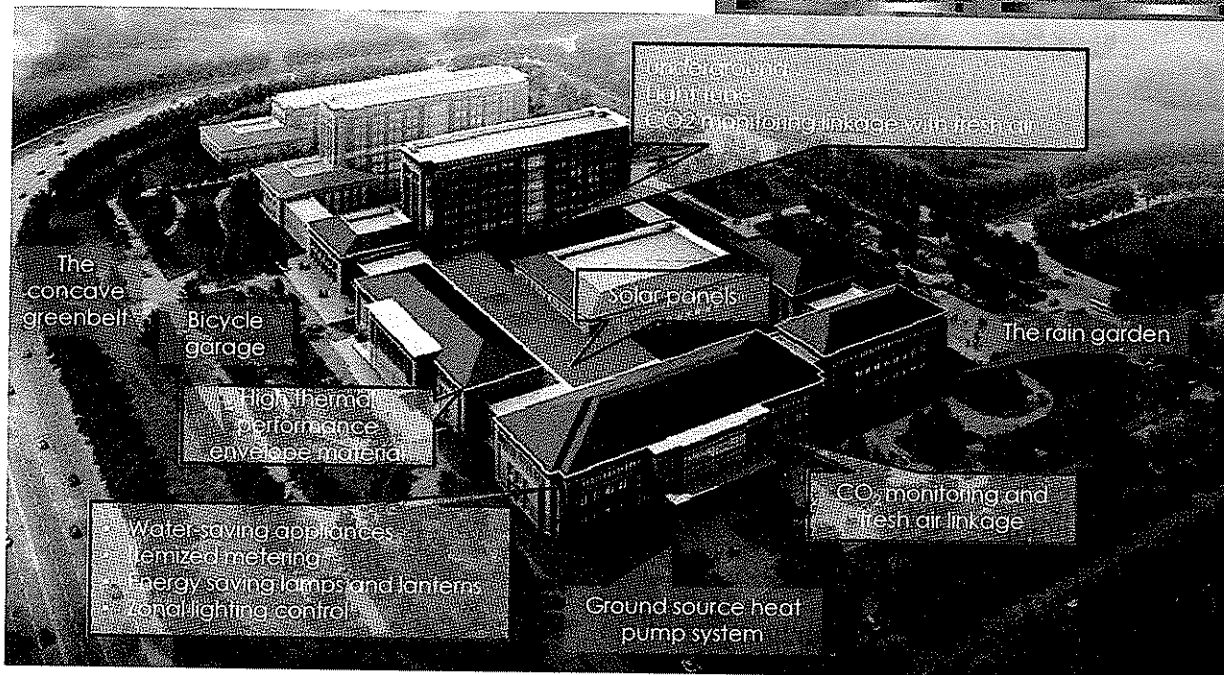
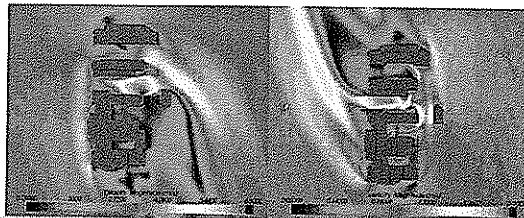

Integrated control system under the comprehensive guidance of electromechanical

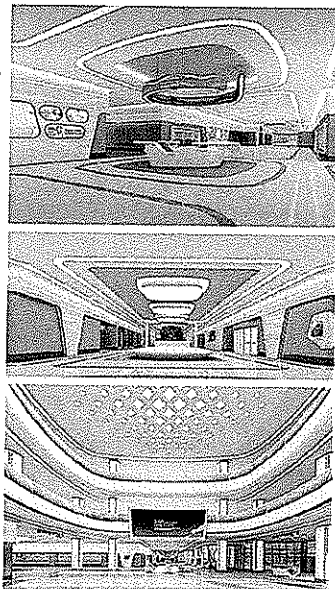
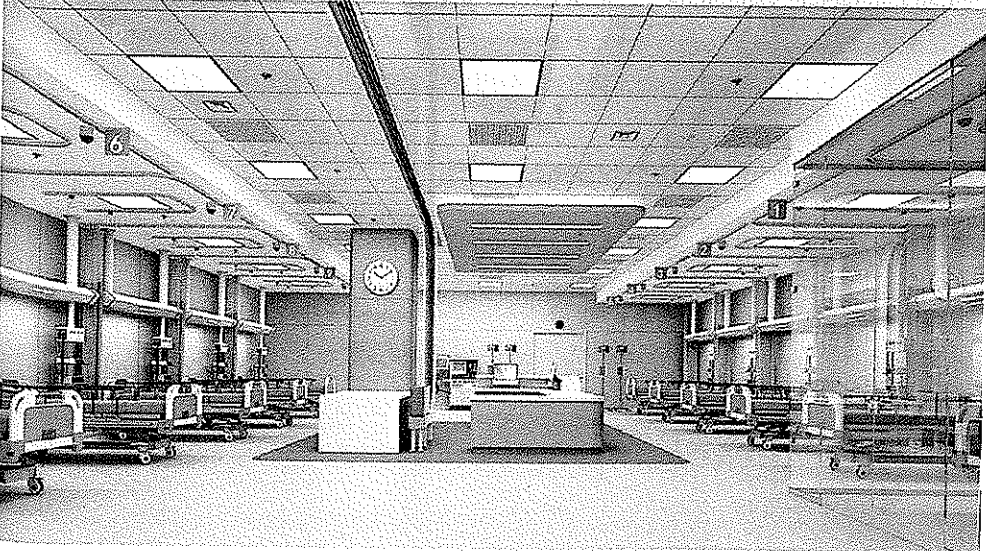



Personal digital health files Resume reminders Follow-up after diagnosis Smart wear Call number query Information inquiry In-hospital navigation Mobile payment Query report

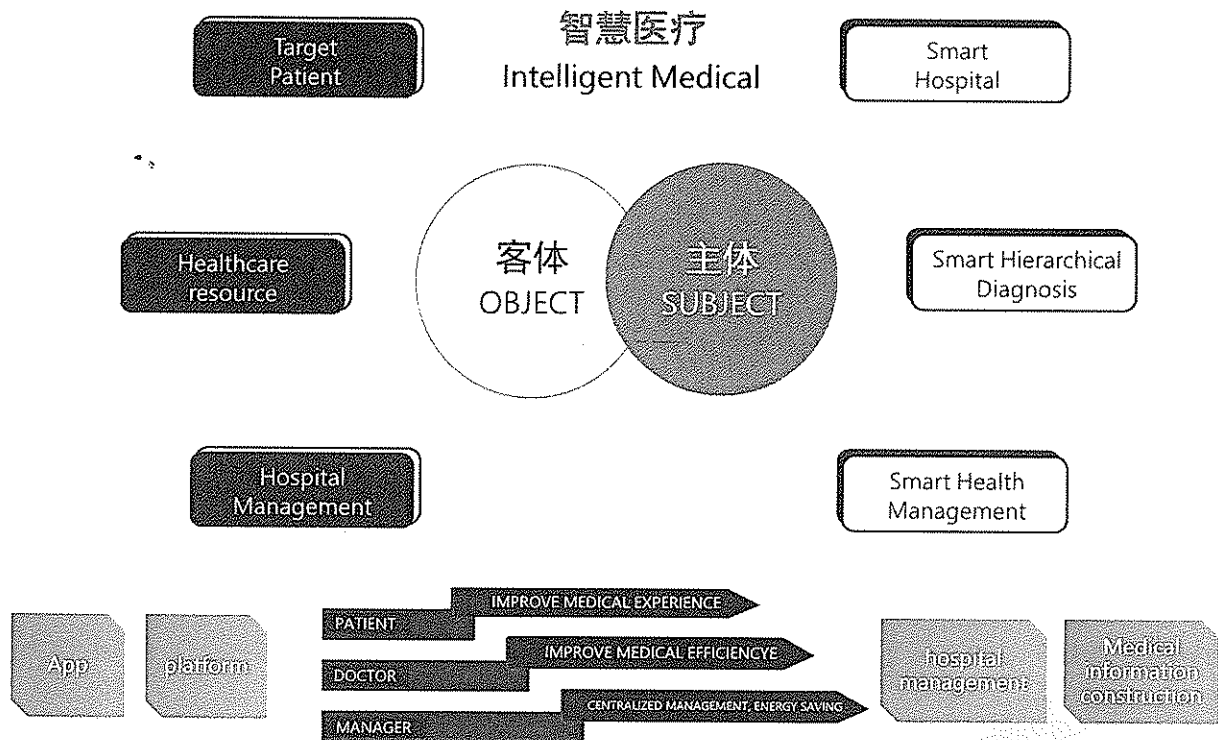

Online

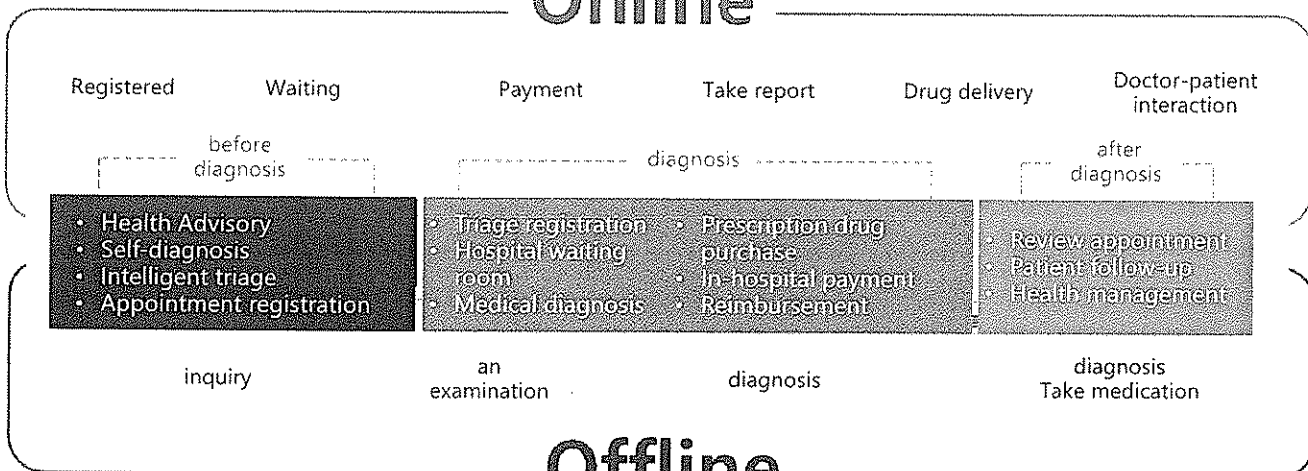

Offline

0000000000

医院医疗质量运营管理系统
 Hospital medical quality operation management system



医疗质量监管
 Medical quality supervision



医疗安全管理
 medical safety management



临床用药监控
 Clinical medication monitoring



医疗数、质量指标
 Medical data, quality index

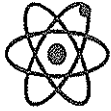

质量考评管理
 Quality evaluation management



辅助工具
 auxiliary means



学术研究科研
 Academic research and research



系统管理
 system management

优质服务
 QUALITY SERVICE

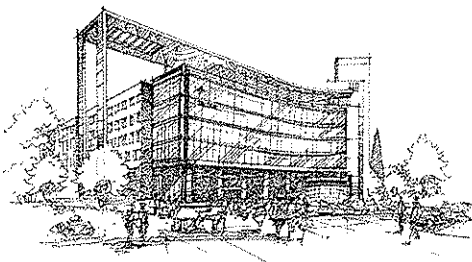

经营策略
 Management Strategy



EPC RUNNING SYSTEM

The engineering general contract running system shows the key role of design in the whole process of plan and coordinate implementation and running of the entire engineering general contract running system.

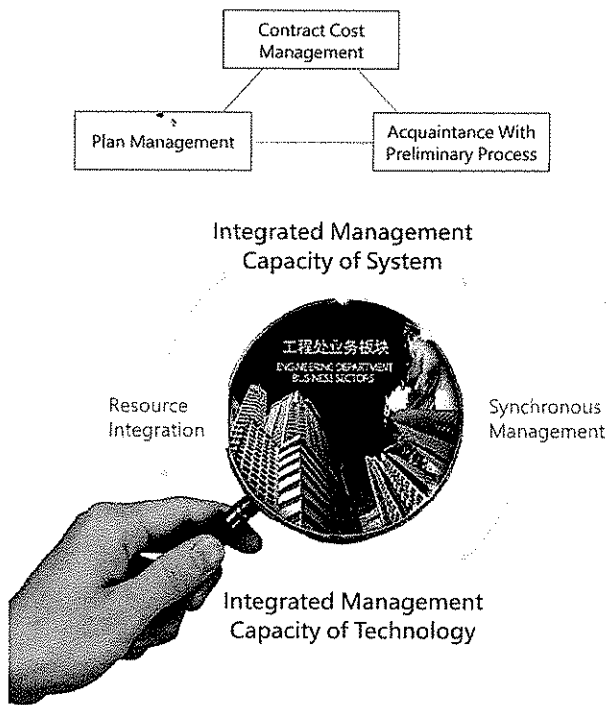

The EPC engineering general contract led by design has four advantages as follows.

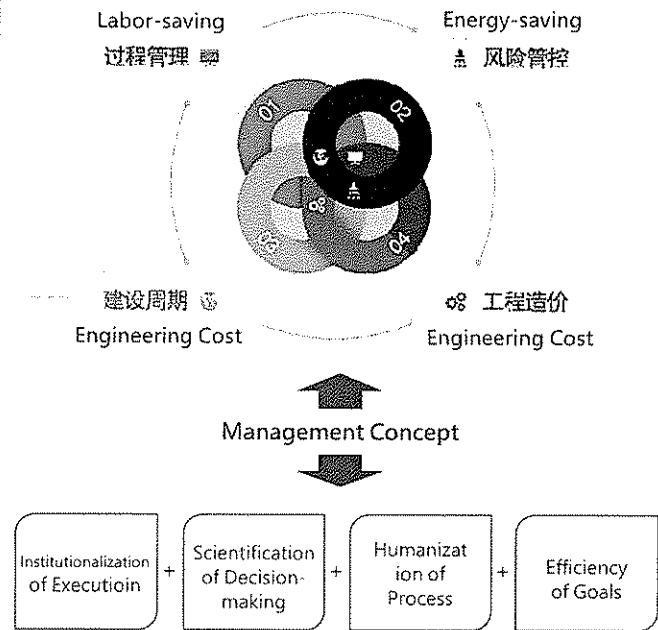

RELEVANT PROJECTS

Category of Hospital	Quantity (items)
General Hospital	34
Specialized Hospital	28
TCM Hospital	6
Health Institution and Welfare Facility	6
Township Community Health Center	25
Facility for the elders	3
Specialized Design	7
Total	109
Total Construction Area	4.8million m ²
Total Beds	350,00 beds

Award Level	Quantity (items)
International	1
National	10
Ministerial and Provincial	12
Total	23



医疗卫生建筑 MEDICAL BUILDINGS

天津市人民医院

Tianjin People's Hospital

Construction Location: Tianjin
Structural Form: Frame
Structure
Construction Area: 135,000 m²
Design Beds: 1,500
Floors/Height: 17 floors/72.5m
Date of Design and
Completion: 2002/2004
Main Functions: outpatient
service, healthcare, in-patient
service
Grade-III A General Hospital



- First Prize of 2004 Tianjin
Excellent Survey and Design
- Top 10 of First National
Hospital Construction Design
- First Prize of 2008 National
Hospital Construction Design

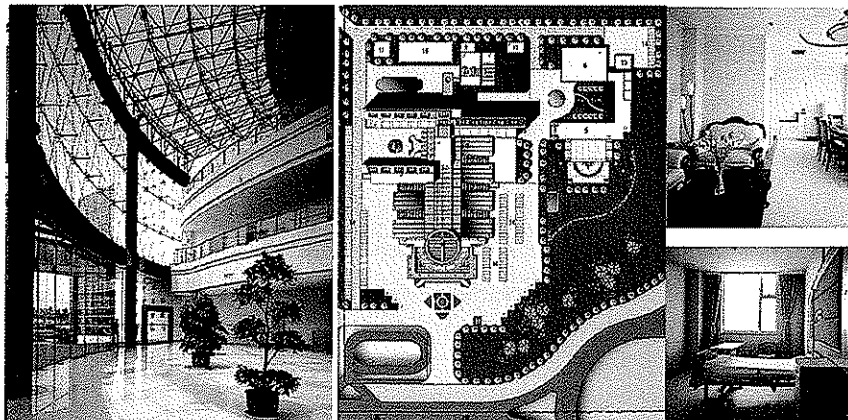



天津市人民医院 Tianjin People's Hospital

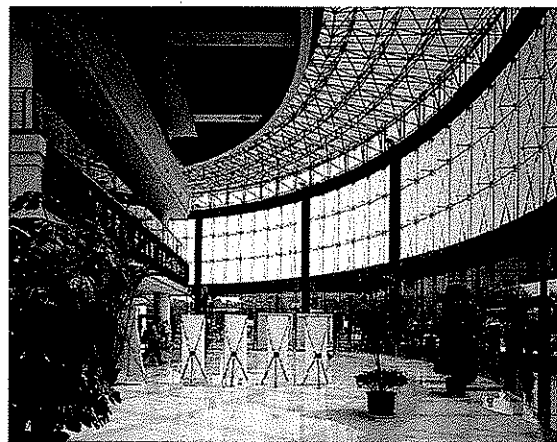

医疗卫生建筑 MEDICAL BUILDINGS

天津市中心妇产科医院

Tianjin Central Hospital of
Gynecology Obstetrics

Construction Location: Tianjin
Structural Form: Frame-shear Wall
Structure
Construction Area: 71500 m²
Floors/Height: 19 floors/85.7m
Date of Design: 2007
Main Functions: outpatient service,
healthcare, in-patient service, R&D
Grade-III A Specialized Hospital
Take the healthcare feature of
'mixed joy and sorrow'
(obstetric and gynecology
department) and professionalism
and particularity of female patient
healthcare in fully consideration
and apply 'separate doctor and
patient, private examination room,
function division' and other
methods.

- Second Prize of Tianjin Excellent Survey and Design
- Top 10 of Second Hospital Architecture Design
- Luban Award of Ministry of Construction



天津市中心妇产科医院 Tianjin Central Hospital of Gynecology Obstetrics

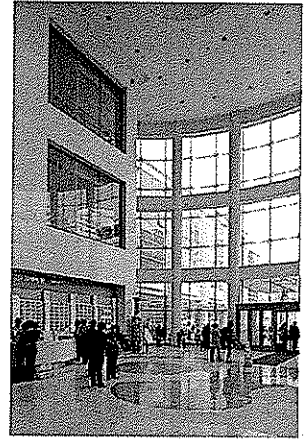
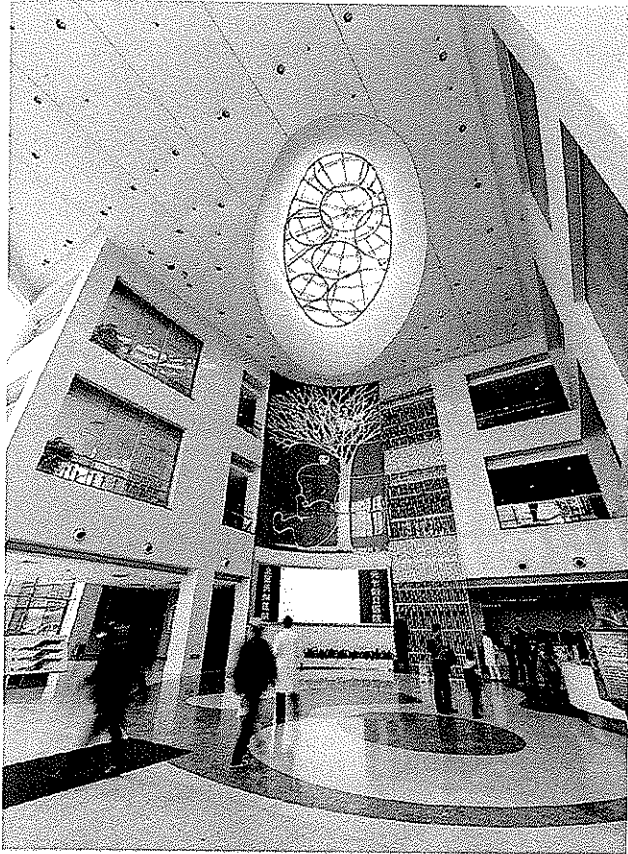

医疗卫生建筑 MEDICAL BUILDINGS

天津中医药大学第一附属医院
First Teaching Hospital of
Tianjin University of TCM

Construction Location: Tianjin
Structural Form: Frame-shear Wall
Structure
Construction Area: 160,000m²
Design Beds: 1,500
Date of Design: 2011
Main Functions: outpatient service, healthcare, in-patient service, R&D
Use the integrated design, air-conditioner coverage environment, rational function layout, efficient and convenient transportation streamline. Use the layout mode of hospital street and modular outpatient service medical technology, the flow distribution method of doctor-patient diversion, the pneumatic transmission logistics system and other modern logistics and information flow methods to meet the demand of large outpatient service quantities, reduce the labor intensity of healthcare staffs, shorten treatment streamline of patients for the complete construction of modern TCM hospital.

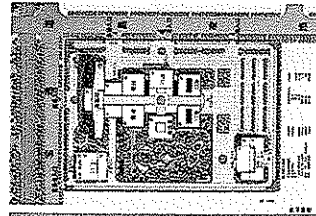
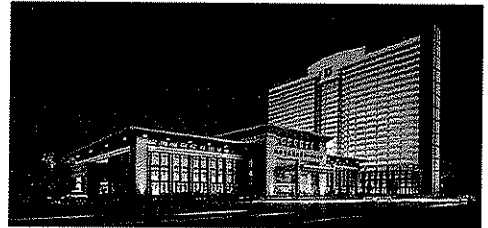
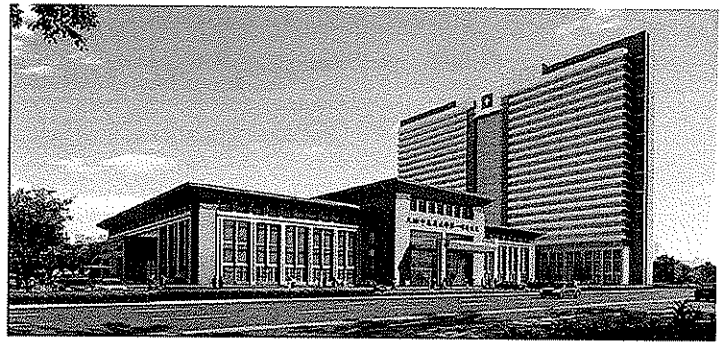



天津中医药大学第一附属医院

The first affiliated hospital of tianjin university of traditional Chinese medicine

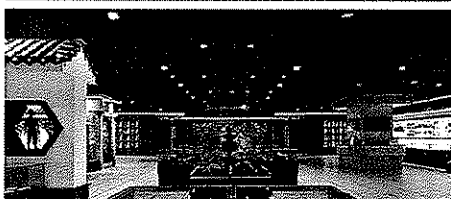

医疗卫生建筑 MEDICAL BUILDINGS

天津市环湖医院

Tianjin Huanhu Hospital

Construction Location: Tianjin

Structural Form: Frame-shear

Wall Structure

Construction Area: 120,000m²

Design Beds: 1,000

Floors/Height: 10 floors/48.4m

Date of Design: 2012

Main Functions: healthcare, in-patient service

Grade-III A Specialized Hospital

We put forward the conception of future hospital running and management mode in accordance with the construction location, surrounding environment, people flow direction, traffic flow, regional annual prevailing wind, function requirements and other factors through analysis. Finally, the integrated construction combination method was adopted.

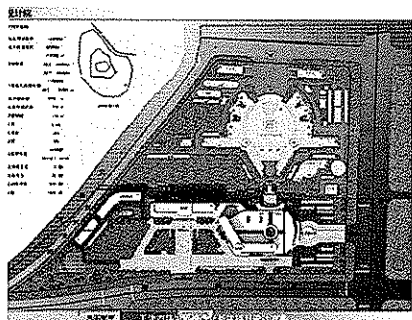
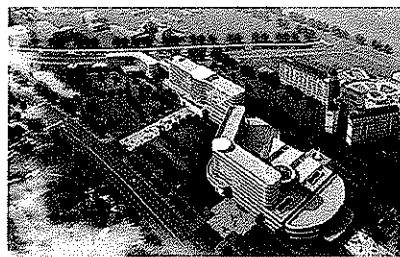
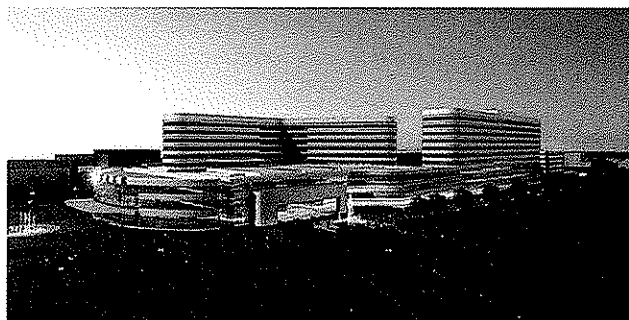

天津市环湖医院 Tianjin Huanhu Hospital

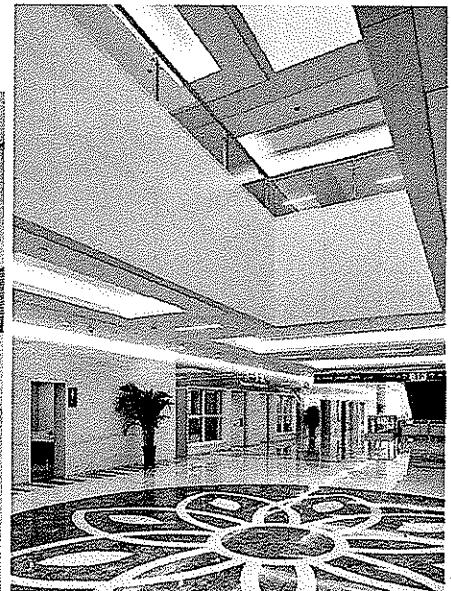
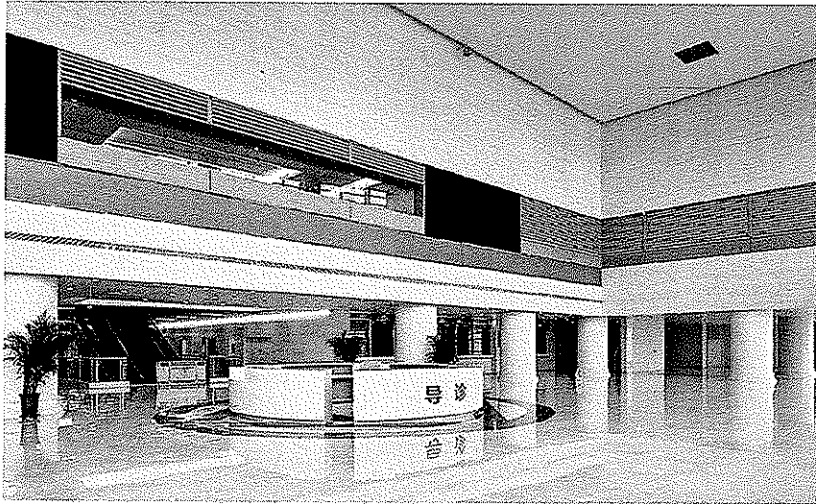
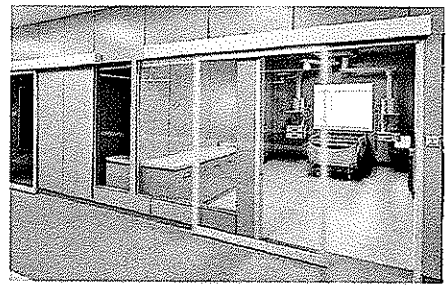
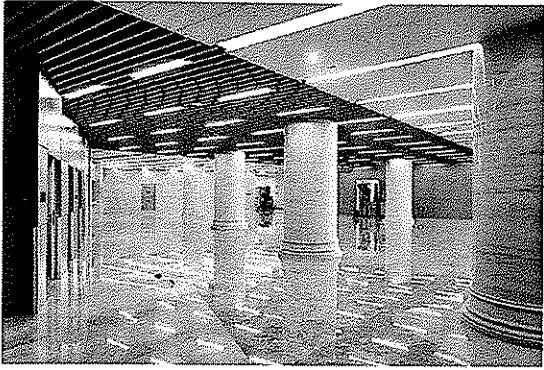

医疗卫生建筑 MEDICAL BUILDINGS

天津市南开医院

Tianjin Nankai Hospital

Construction Location: Tianjin
Structural Form: Frame-shear
Wall Structure
Construction Area: 86000m²
Design Beds: 800
Floors/Height: 16 floors/74.4m
Date of Design: 2008
Main Functions: healthcare, in-patient service
Grade-III A General Hospital



Integrated layout; various in-and-out streamline is clear without obstruction and intersection; focus on the design concept of future development; 'fish bone' shape of horizontal traffic, area and category division set of vertical traffic mode; humanization of space creating shows humanistic concern.

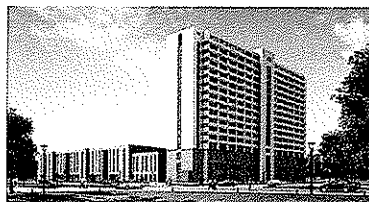
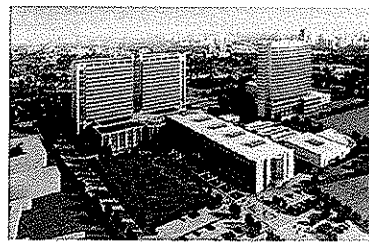
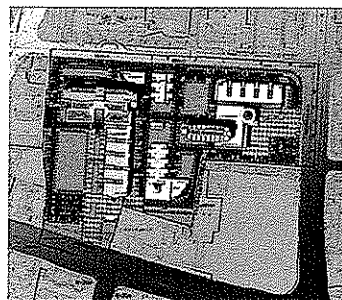

天津医科大学总医院

Tianjin Medical University
 General Hospital

Construction Location: Tianjin
 Structural Form: Frame-shear
 Wall Structure
 Construction Area: 160,000m²
 Design Beds: 1500
 Floors/Height: 17 floors/75m
 Date of Design and Completion:
 2005/2009
 Main Functions: out-patient
 service, healthcare, in-patient
 service



·Luban Award of Ministry of
 Construction

·First Prize of 2006 Tianjin
 Excellent Survey and Design

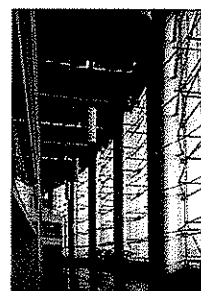
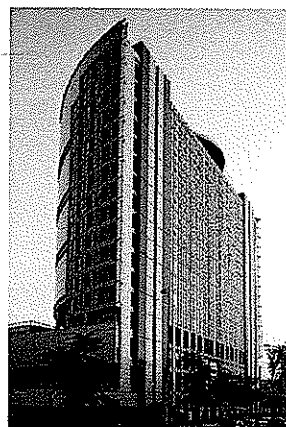

天津市胸科医院

Tianjin Chest Hospital

Construction Location: Tianjin
 Structural Form: Frame-shear
 Wall Structure
 Construction Area: 116000m²
 Design Beds: 900
 Date of Design: 2010
 Main Functions: out-patient
 service, healthcare, in-patient
 service, R&D
 Grade-III A Specialized Hospital

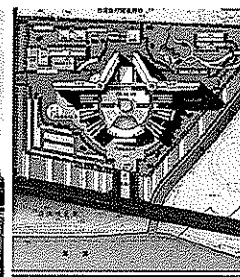
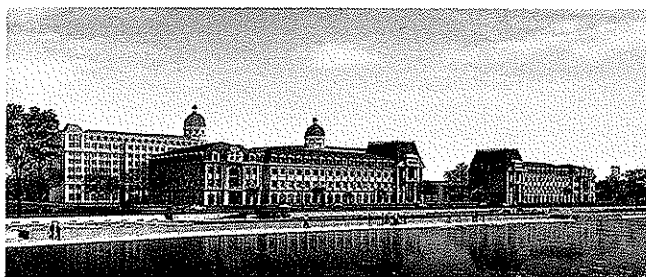

天津市胸科医院 Tianjin Chest Hospital



养老中心建筑 PENSION CENTER BUILDINGS

河北省迁安市老年康复中心
Hebei Qianan Elder
Rehabilitation Center

Construction Location: Qianan,
Hebei
Area: 13 ha.
Construction Area: 190,000m²
Floors/Height: 11 floors/44m
Date of Design and Completion:
2012/under construction
Main Functions: nursing,
rehabilitation

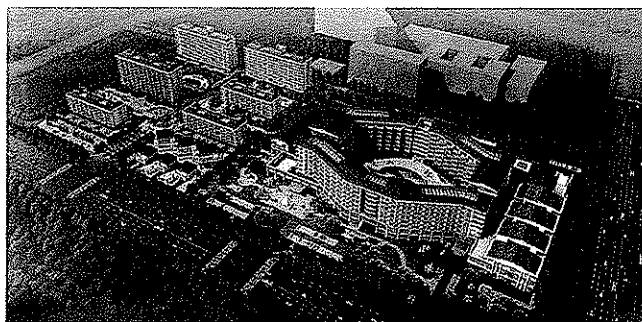

Tianjin Eye Hospital

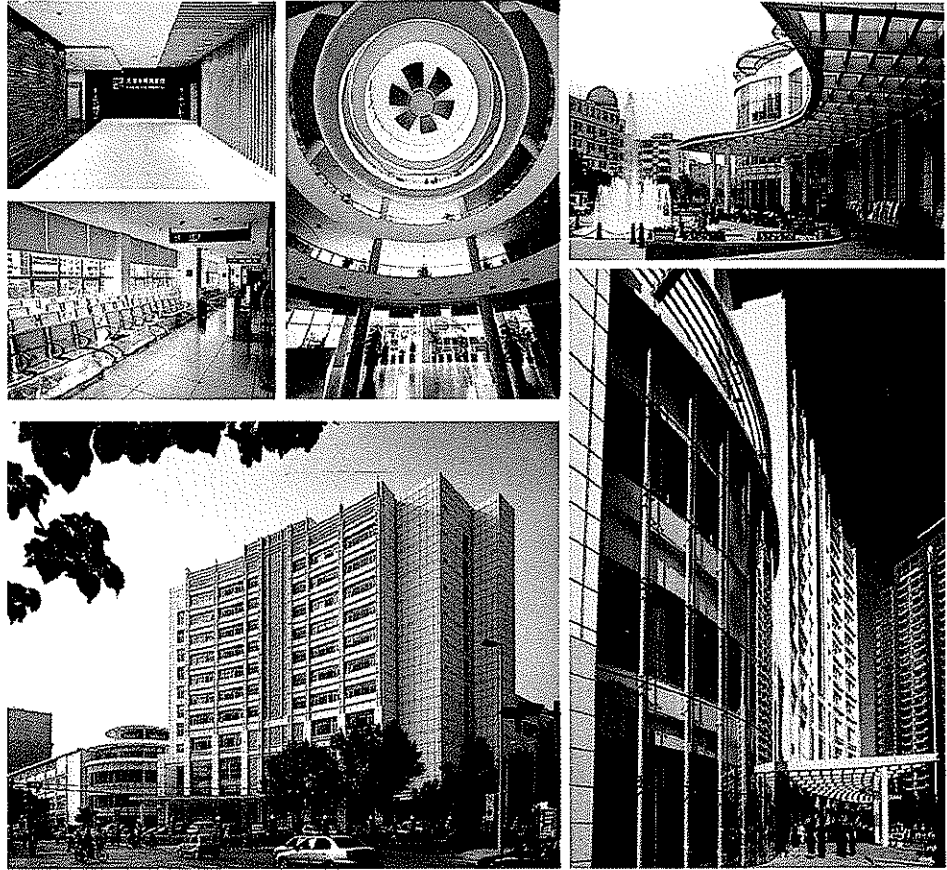

·Second Prize of National Hospital Association Design

·Third Prize of Tianjin Excellent Survey and Design

·Excellent Engineering Prize of Tianjin Haihe Competition

天津市河西医院 Tianjin hexi hospital

Construction site: hexi district, tianjin
 Structure: frame scissors
 Floor area: 75,000 m²
 Design beds: 620 beds

Floors/height: 13F/45m
 Design/completion: 2015
 Main application: outpatient, medical treatment, hospitalization
 Grade a general hospital

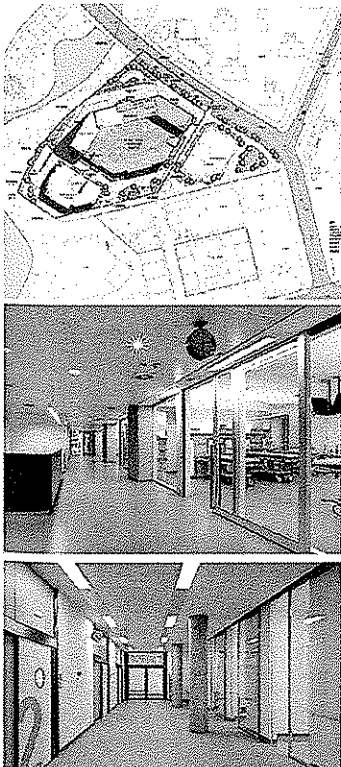

天津市河西医院 Tianjin hexi hospital

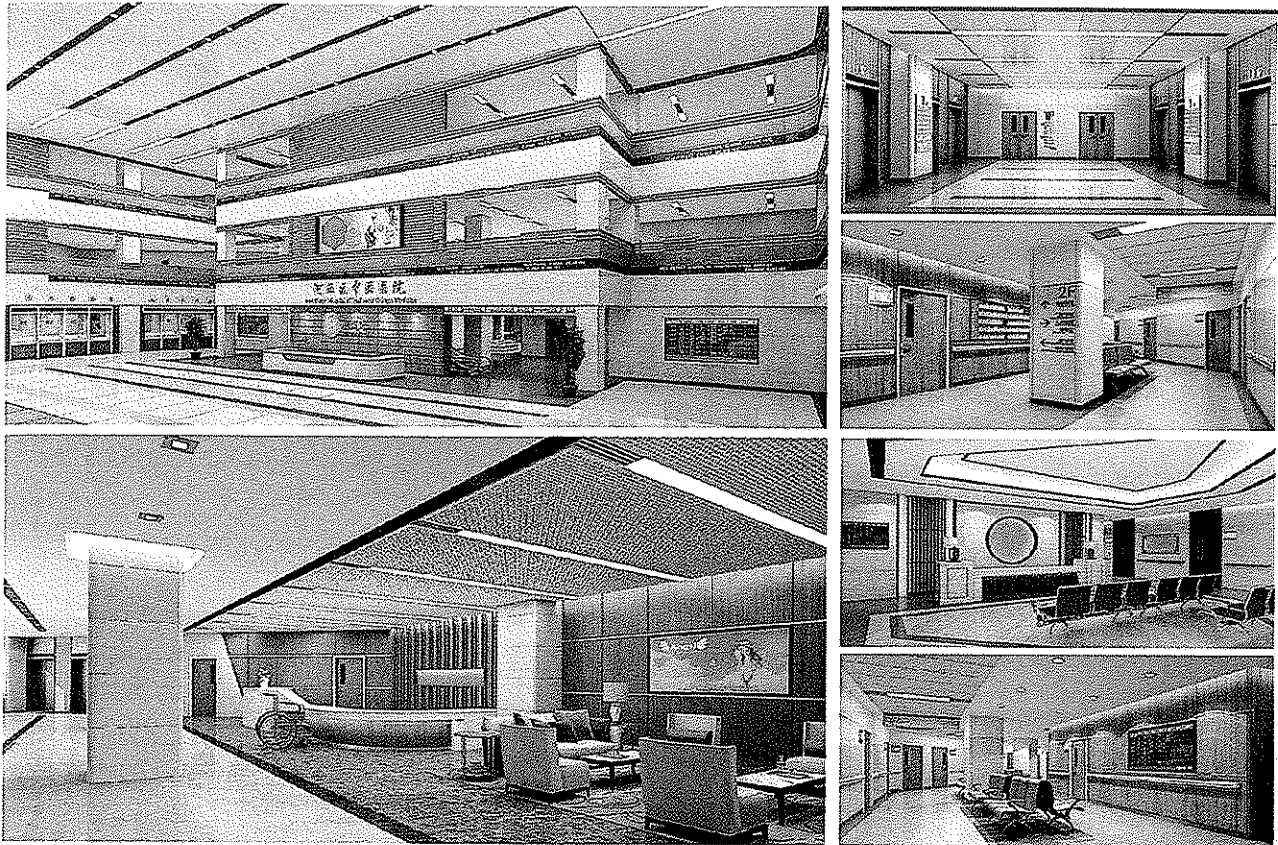

天津市肿瘤门诊医技楼

Construction site: hexi district, tianjin

Structure: frame scissors

Floor area: 80,000 m²

Floors/height: 10F/50m

Design/completion: 2015 /2019

Main application: outpatient, medical treatment

Grade a specialist hospital

天津市肿瘤医学转换综合楼

Construction site: hexi district, tianjin

Structure: frame core tube

Floor area: 140,000 m²

Floors/height: 33F/135m

Design/completion: 2016

Main application: office, physical examination and experiment

Grade a specialist hospital



Tianjin Konggang Taishan Tumour Hospital

Location: Tianjin airport economic zone
 Structure: frame scissors
 Building area: 120,000 m²
 Designed beds: 1000 beds
 Number of floors/height: 9F/41m
 Design/completion: 2014 /2018
 Main USES: outpatient, medical treatment, inpatient,
 research center, physical examination center
 Grade a specialist hospital

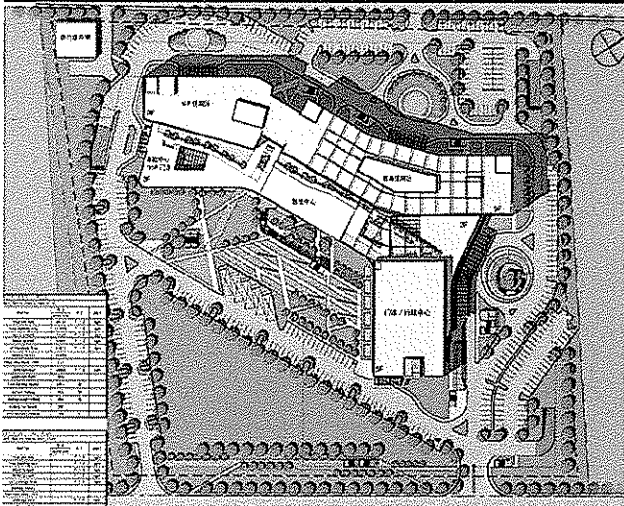
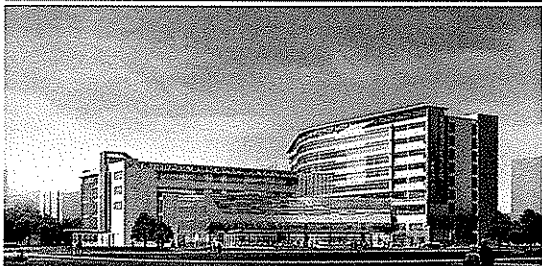

天津空港国际生物医学康复治疗中心

Tianjin airport international biomedical rehabilitation center

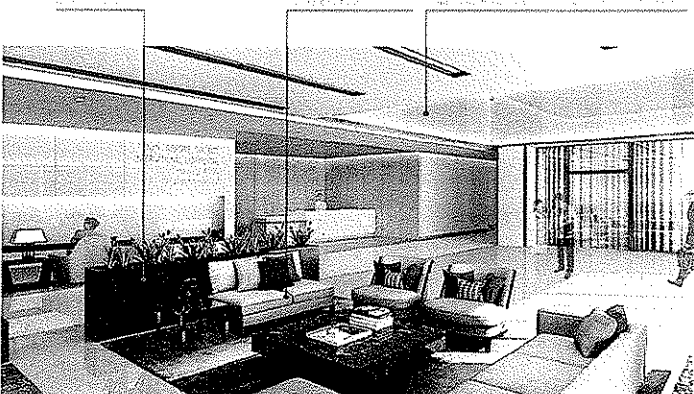
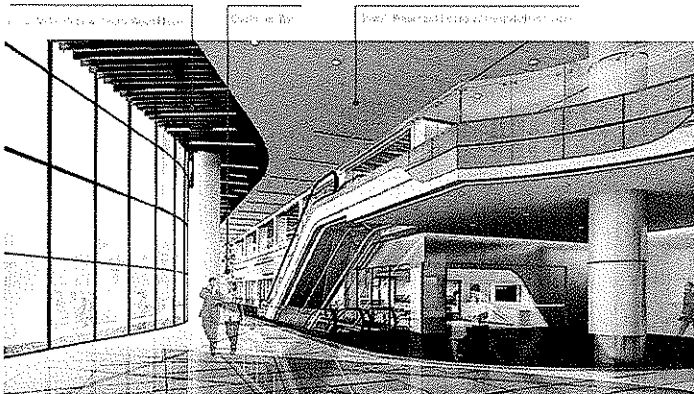

天津空港太山质子中心
Tianjin airport tai shan proton center

Location: tianjin airport economic zone
Structure: frame scissors
Building area: 40,000 m²
Number of floors/height: 9F/41m
Design/completion: 2018
Main USES: clinic, proton center, training center, expert apartment

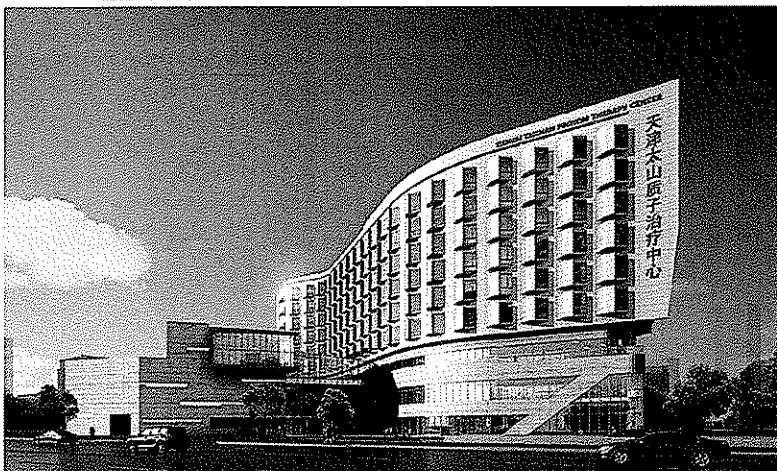
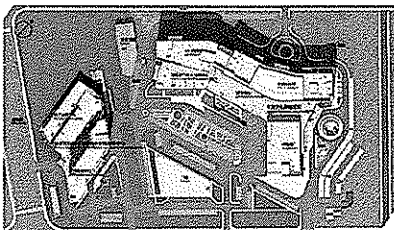

滨海新区肿瘤医院

Binhai New District Tumour Hospita

Location: binhai new area, tianjin
Structure: frame scissors
Floor area: 150,000 m²
Design beds: 1200 beds
Floor number/height: 8F/40m
Design/completion: 2015 /2019
Main USES: outpatient, medical treatment, inpatient, physical examination center
Grade a specialist hospital

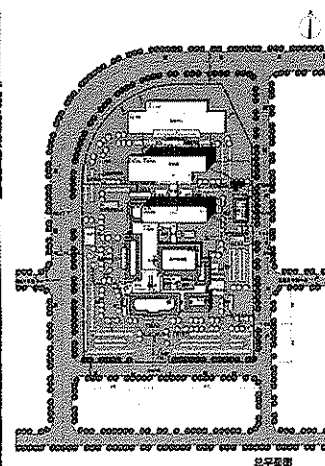
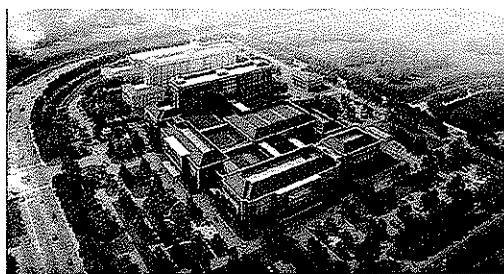
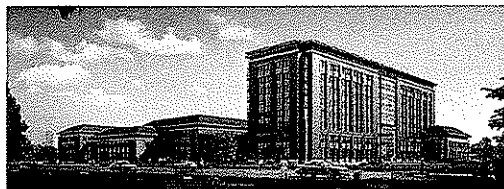

滨海新区肿瘤医院
Binhai New District
Tumour Hospita

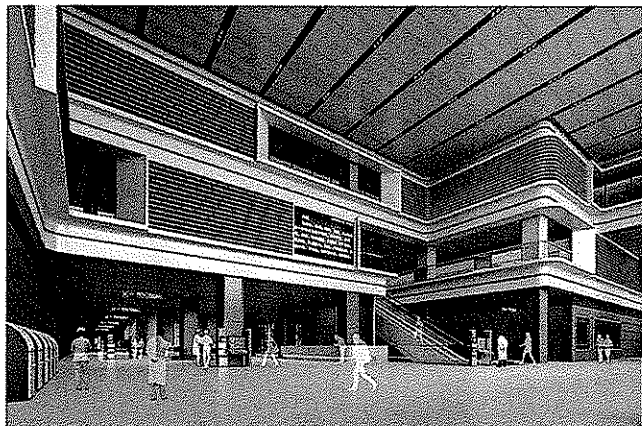

TADI 天津市建筑设计院 医疗设计院
TIANJIN ARCHITECTURE DESIGN INSTITUTE MEDICAL HEALTH CARE ARCHITECTURE DESIGN INSTITUTE

滨海新区肿瘤医院
Binhai New District
Tumour Hospita

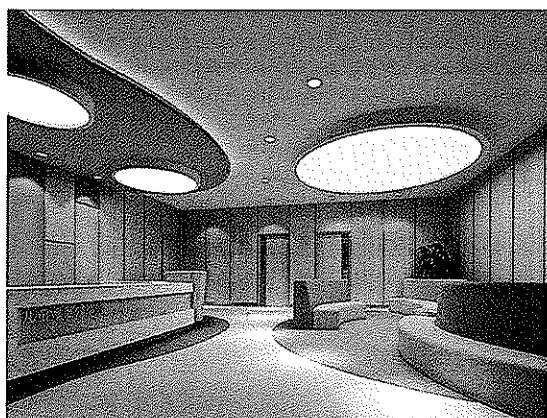
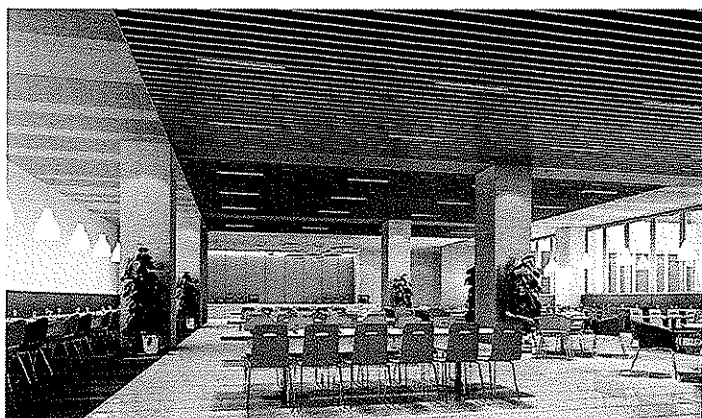
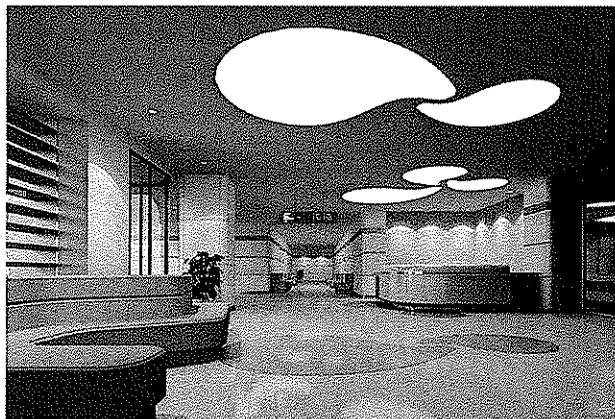

滨海新区肿瘤医院
Binhai New District
Tumour Hospita

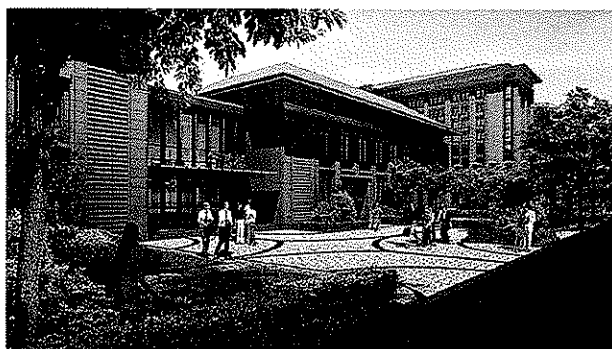
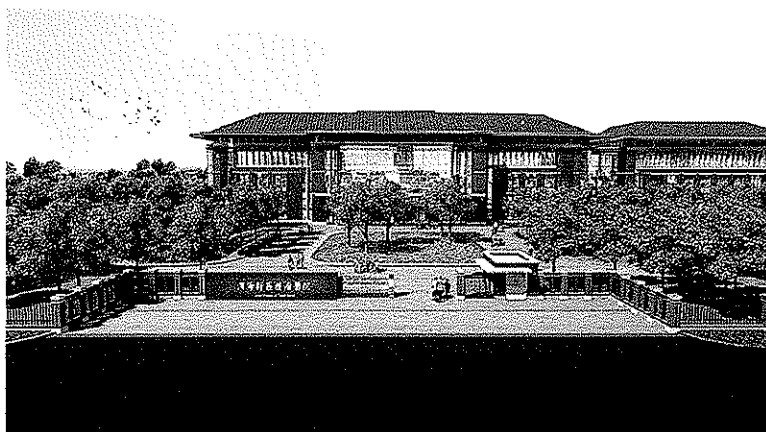

天津市第一中心医院
Tianjin First Central Hospital

Location: xiqing district, tianjin
Structure: frame scissors
Floor area: 380,000 m²
Design beds: 2000 beds
Number of floors/height: 16F/78m
Design/completion: 2013
Main application: outpatient,
medical treatment, hospitalization,
Grade a general hospital

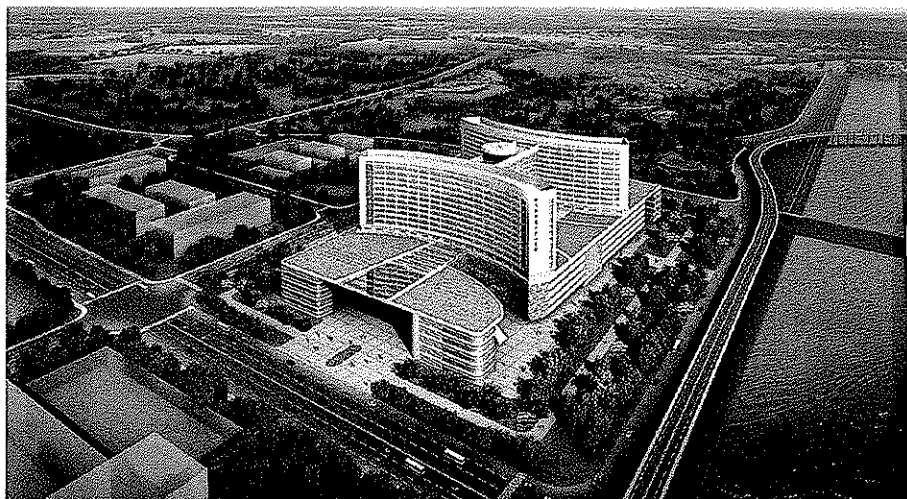

天津市第一中心医院
Tianjin First Central Hospital



天津市第一中心医院 Tianjin First Central Hospital

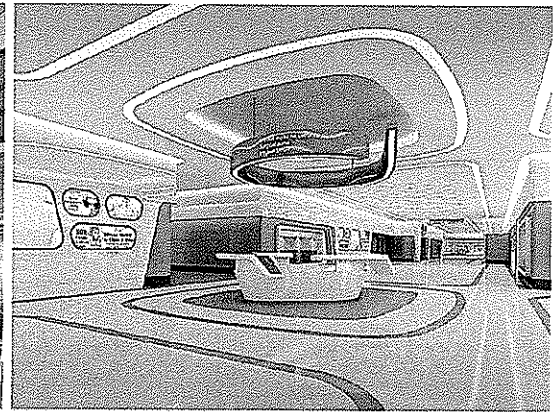
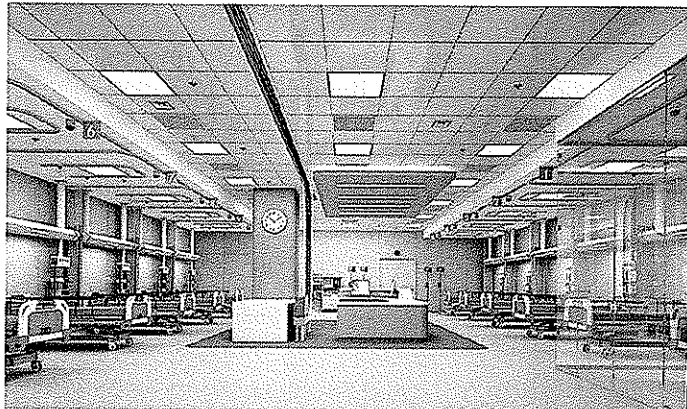

天津市第一中心医院 Tianjin First Central Hospital

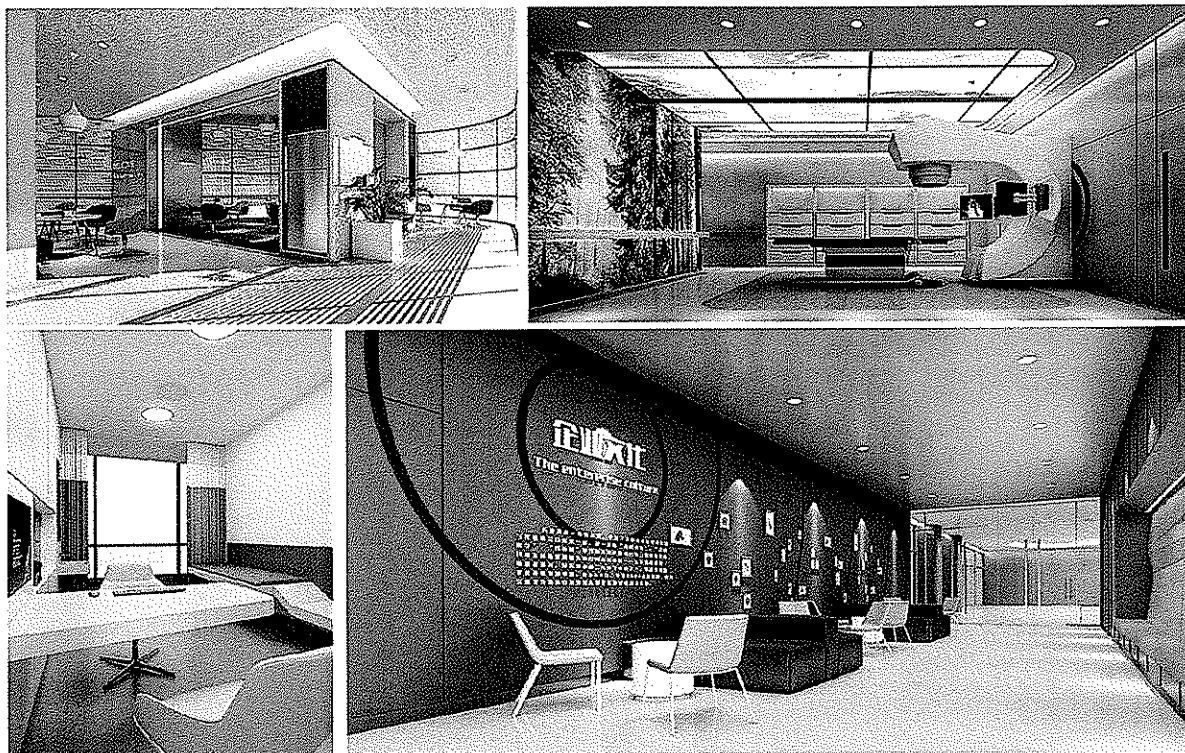

天津市第一中心医院 Tianjin First Central Hospital

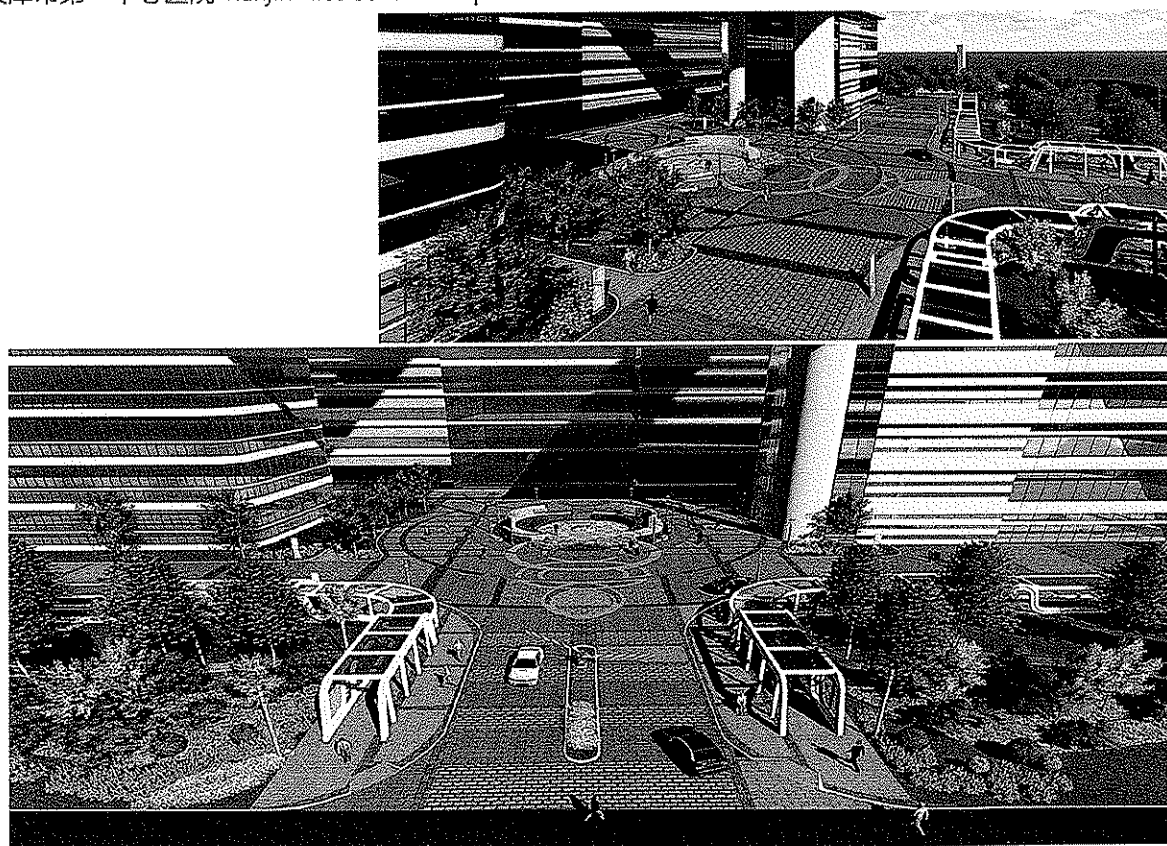

天津市第一中心医院 Tianjin First Central Hospital

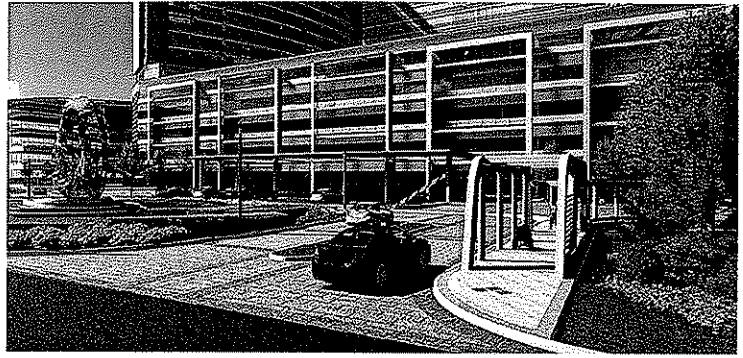

江苏省淮安市妇幼保健院

Huaian Maternal and Child Health Hospital

Location: huai 'an city, jiangsu province
 Structure: frame scissors
 Floor area: 150,000 m²
 Designed beds: 1000 beds
 Floor number/height: 9F/50m
 Design/completion: 2018
 Main application: outpatient, medical treatment, inpatient, rehabilitation
 Grade: a specialist hospital

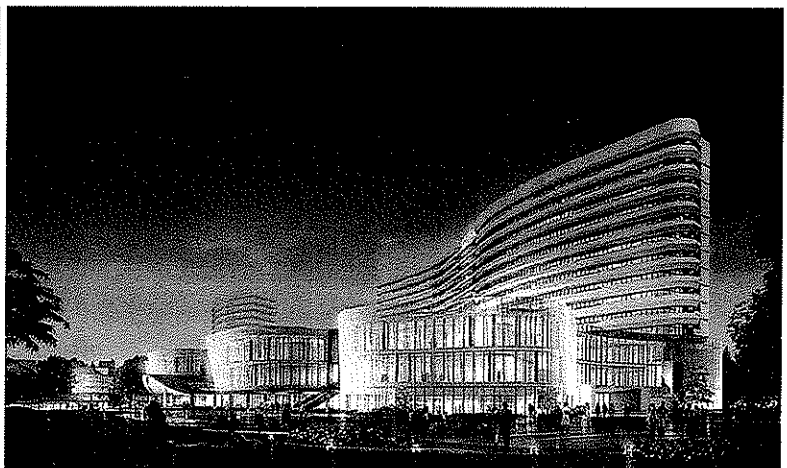
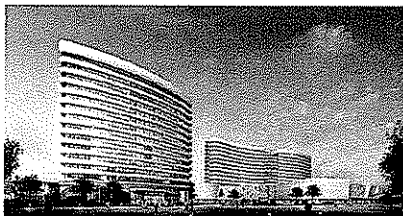
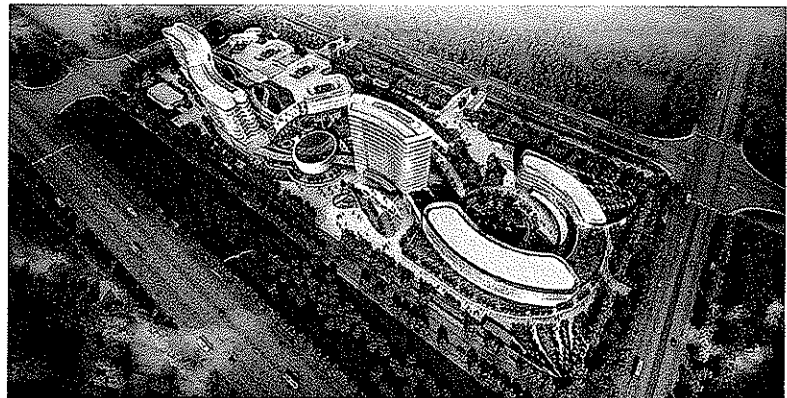

江苏省淮安市妇幼保健院
Huain Maternal and Child Health Hospital

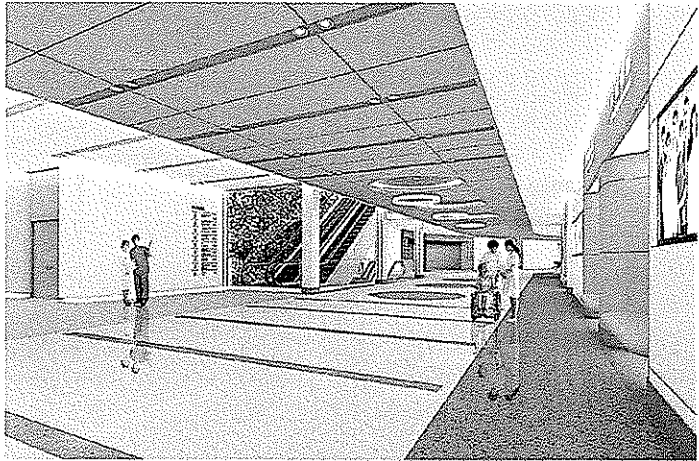

江苏省淮安市妇幼保健院
Huain Maternal and Child Health Hospital

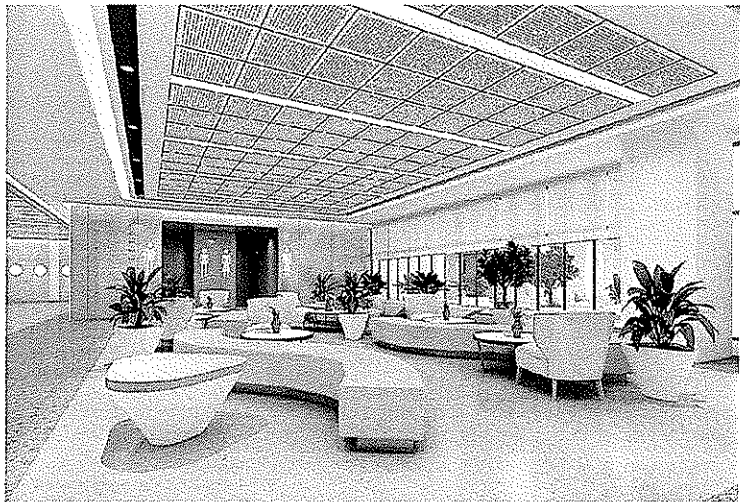

江苏省淮安市妇幼保健院
 Huaian Maternal and Child
 Health Hospital

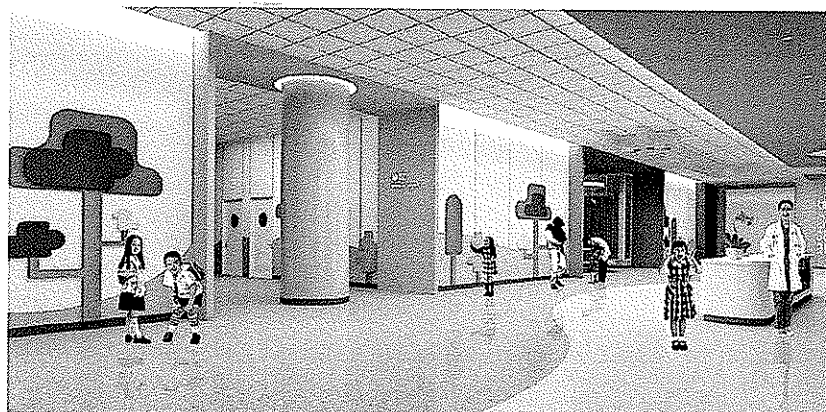
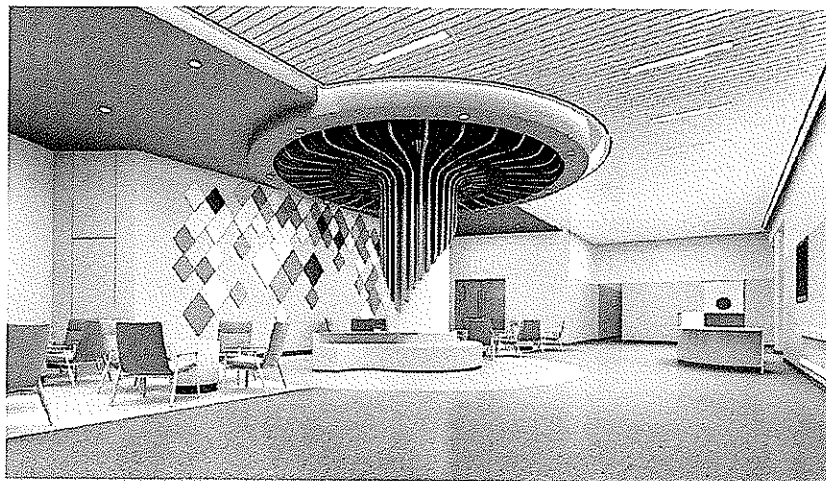

江苏省淮安市妇幼保健院
 Huaian Maternal and Child
 Health Hospital

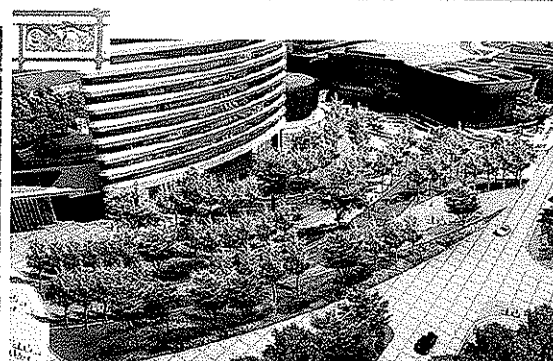
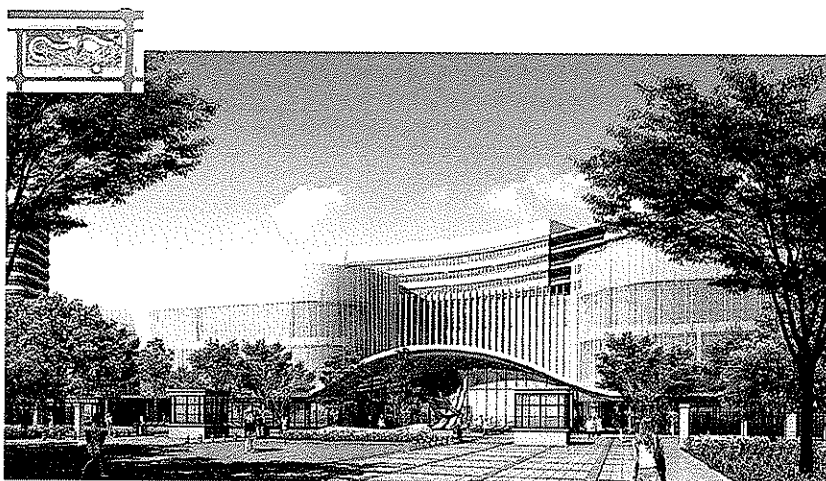

江苏省淮安市妇幼保健院
 Huaian Maternal and Child Health Hospital

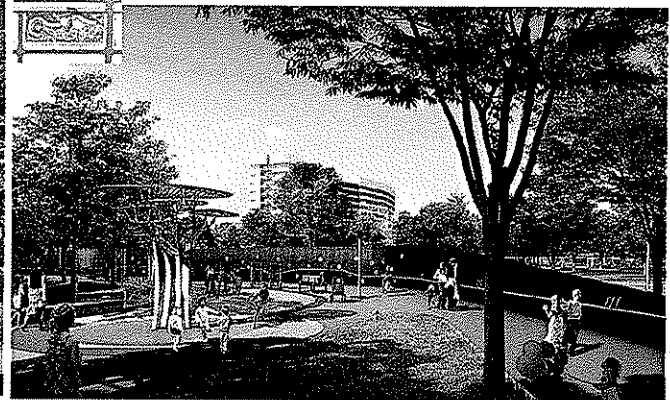
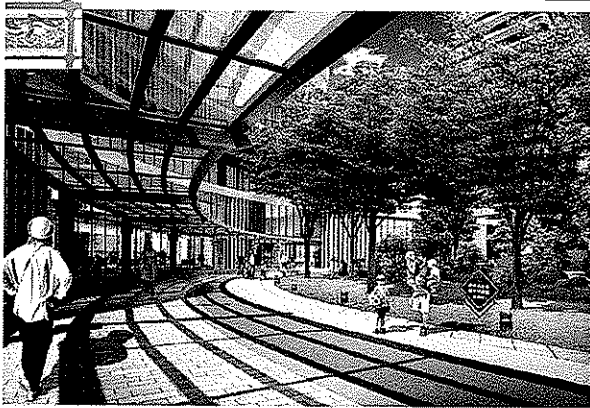
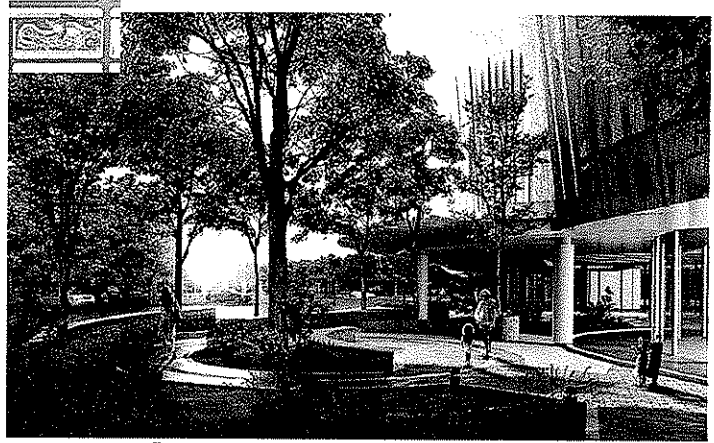

天津市中心妇产原址改扩建工程
 Tianjin Central Obstetrics and
 Gynecology Hospital--original site
 renovation and expansion project

Construction site: heping district, tianjin
 Structure: frame
 Floor area: 30,000m²
 Design beds: 200 beds
 Number of floors/height: 4F/24m
 Design/completion: 2018
 Main application: outpatient service,
 medical treatment, inpatient service,
 assisted pregnancy center
 Grade a specialist hospital

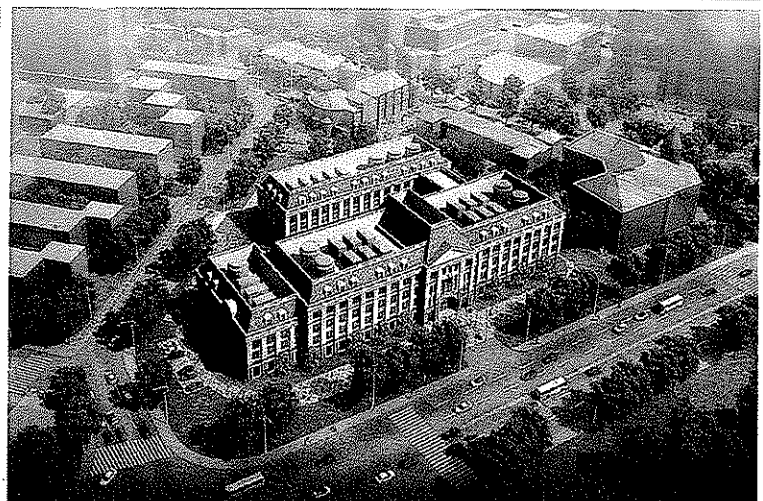
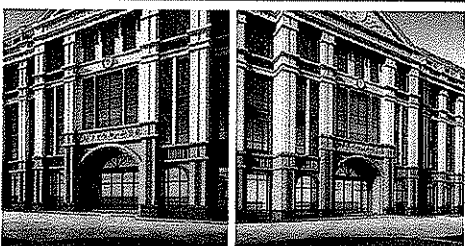

天津市中心妇产原址改扩建工程
Tianjin Central Obstetrics and
Gynecology Hospital--original site
renovation and expansion project

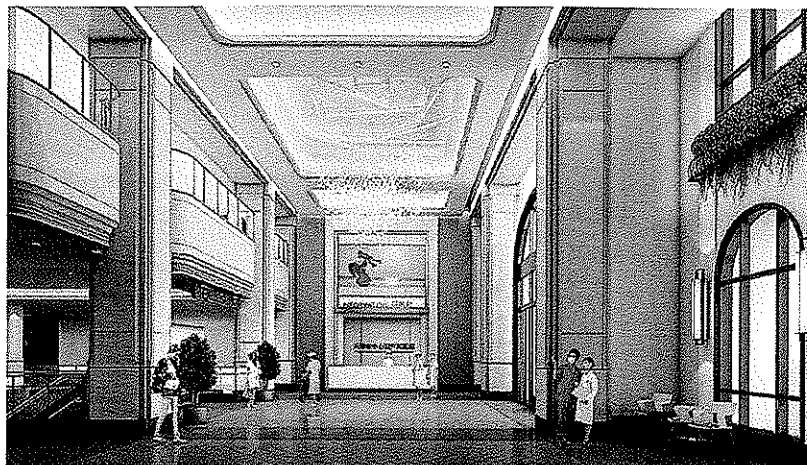

天津市中心妇产原址改扩建工程
Tianjin Central Obstetrics and
Gynecology Hospital--original site
renovation and expansion project

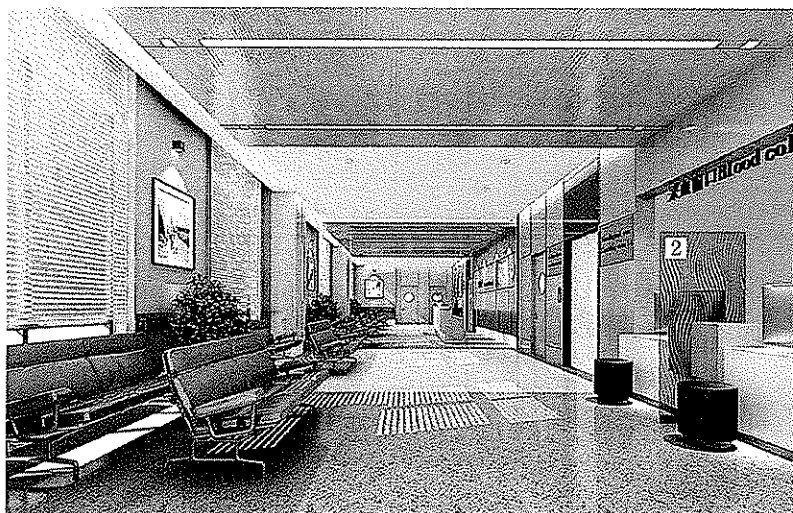

天津市中心妇产原址改扩建工程
Tianjin Central Obstetrics and Gynecology Hospital--original site renovation and expansion project

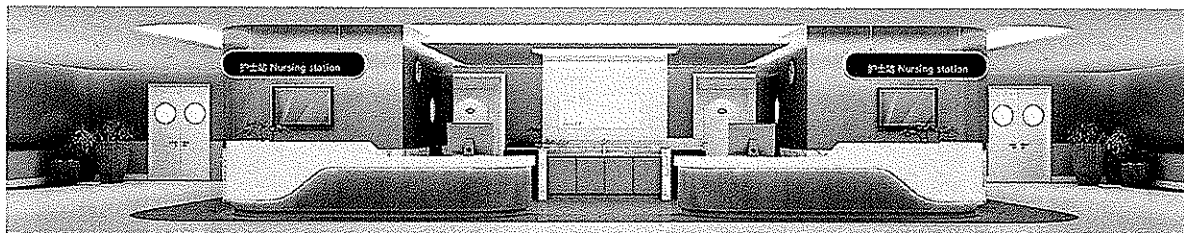
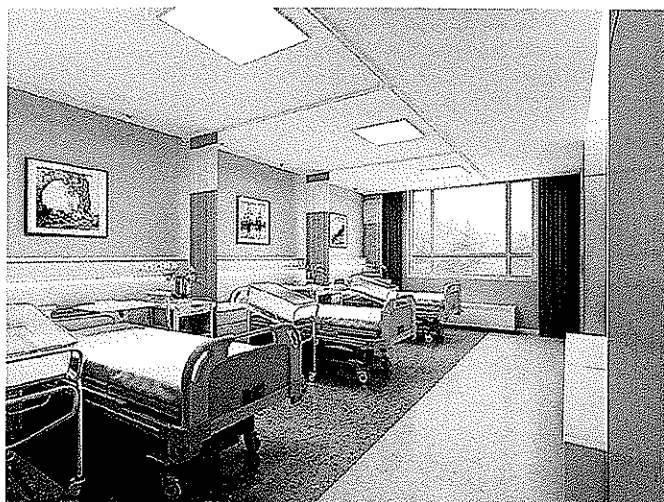

京滨联合医院
Jingbin united hospital

Construction site: Jingbin Industrial Park, Wuqing District, Tianjin
 Structural form: frame
 Building area: 150,000 m²
 Design bed: 1500 beds
 Number of layers / height: 15F / 65m
 Design / Completion: 2018
 Main uses: outpatient, medical, hospitalization, pension, rehabilitation
 Third-grade general hospital

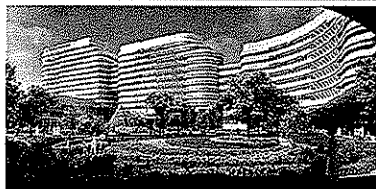
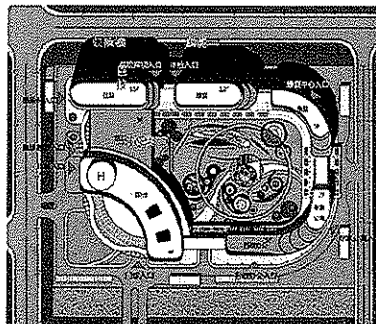
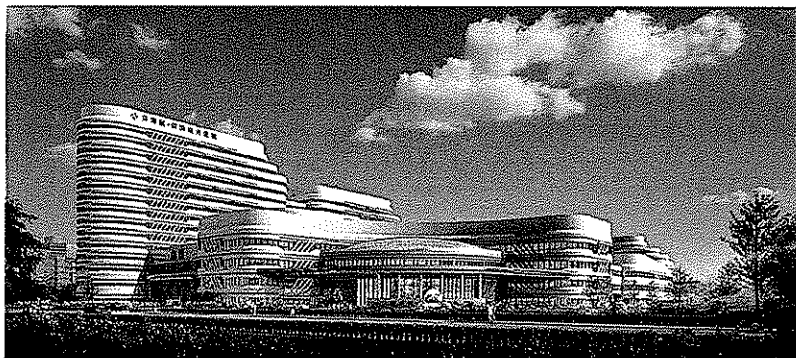

京滨联合医院
 Jingbin united hospital

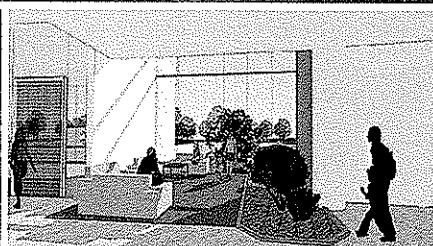
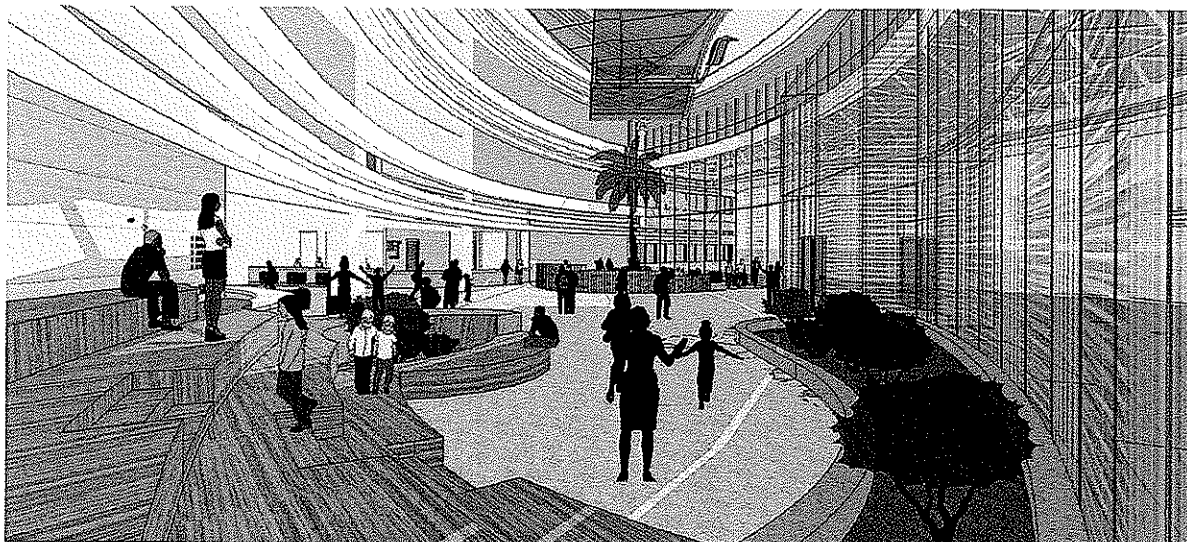

遵义医学院附属医院新蒲医院
 Xinpu hospital, affiliated hospital of zunyi medical college

Construction site: Zunyi
 Structural form: frame
 Building area: 130,200 m²
 Design bed: 1000 beds
 Number of layers / height:
 12F / 54m
 Design / Completion:
 2014/2018
 Main uses: outpatient,
 medical, hospitalization
 Third-grade general
 hospital

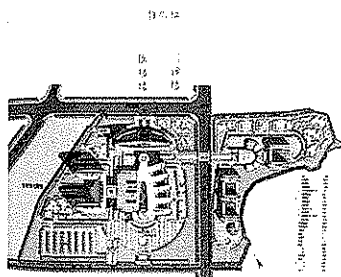
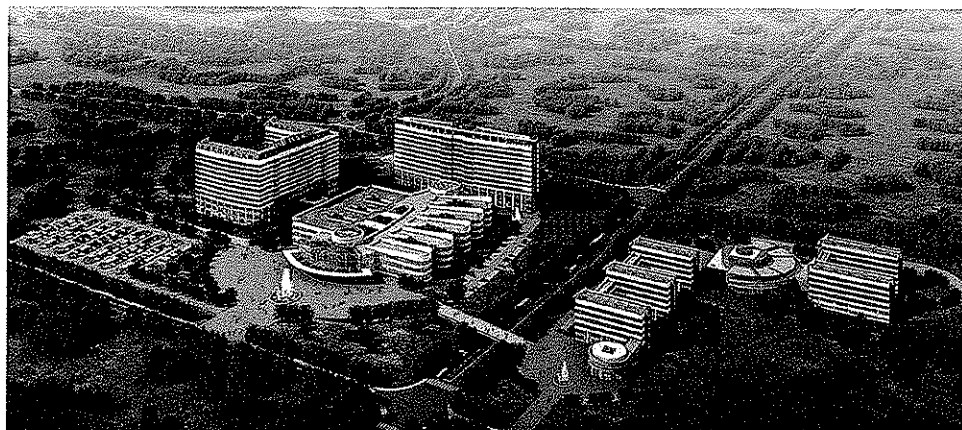

遵义市新蒲新区人民医院
Xinpu New District, Zunyi City
People's Hospital

Construction site: Zunyi City
Structure form: frame structure
Building area: 95,000 m² (Phase I) Design
bed: 500 beds
Number of layers / height: 6F / 31m
Design / Completion: 2015/2019
Main uses: outpatient, medical,
hospitalization
Third-grade general hospital

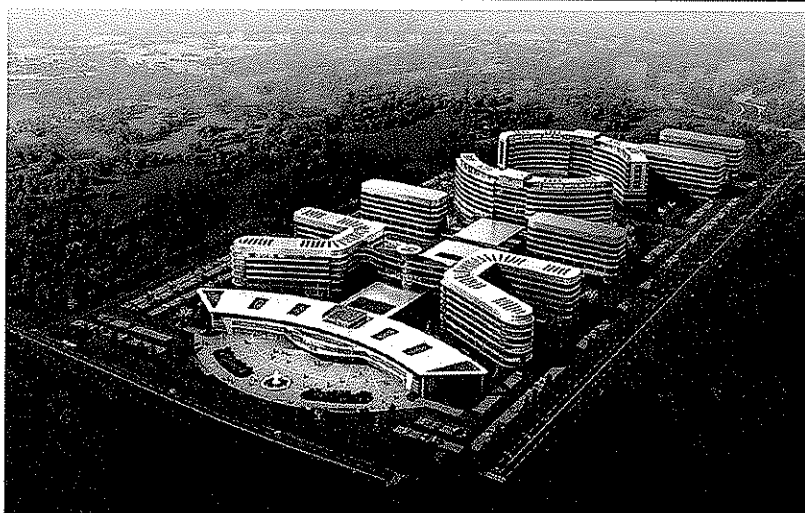
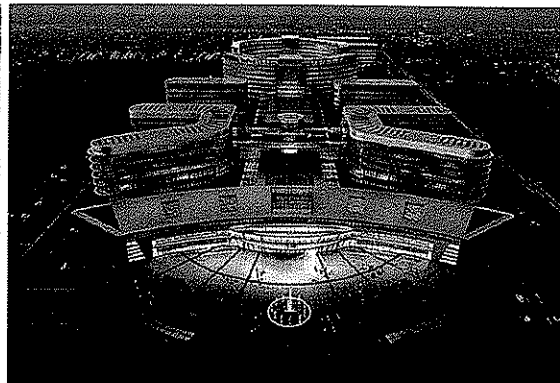
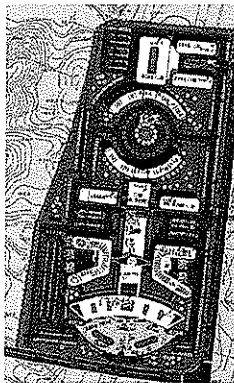

遵义市新蒲新区人民医院
Xinpu New District, Zunyi City People's Hospital

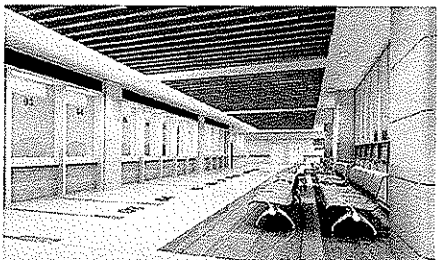
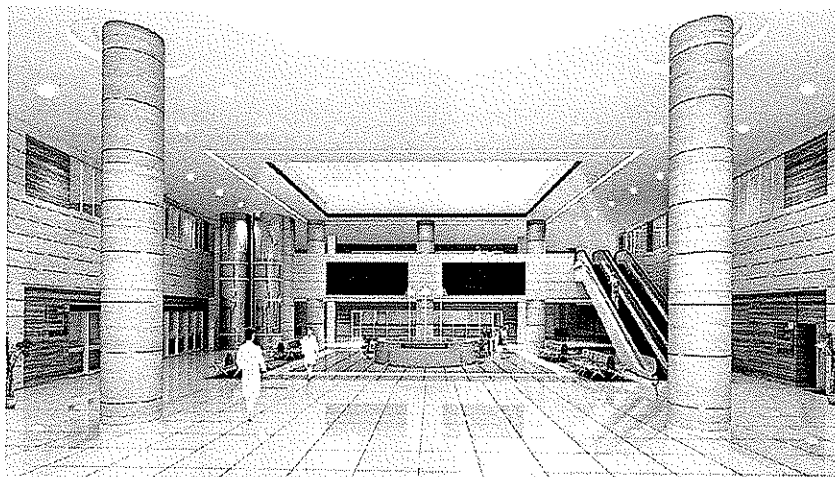

河北省迁安市老年康复中心
Qian'an elderly rehabilitation center, hebei province

Construction site: Qian'an
Structure form: frame shear structure
Land area: 13 hectares
Building area: 190,000 square meters
Number of floors / height: 11 floors / 44 meters
Design / Completion: 2012 / Under Construction
Main use: pension, health

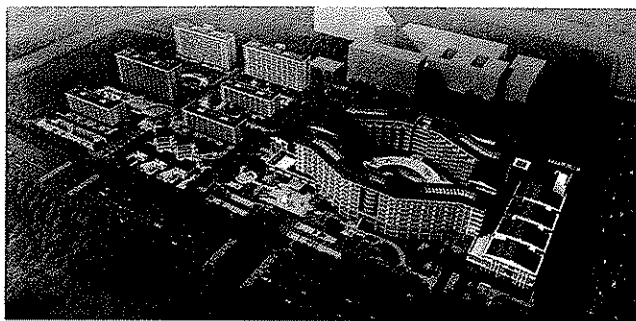

济南舜颐安养中心策划
Jinan shunyi nursing center planning

Land area: 8 hectares
Industry format: medical services
Kang Yang life
Entertainment package
Main use: pension, health

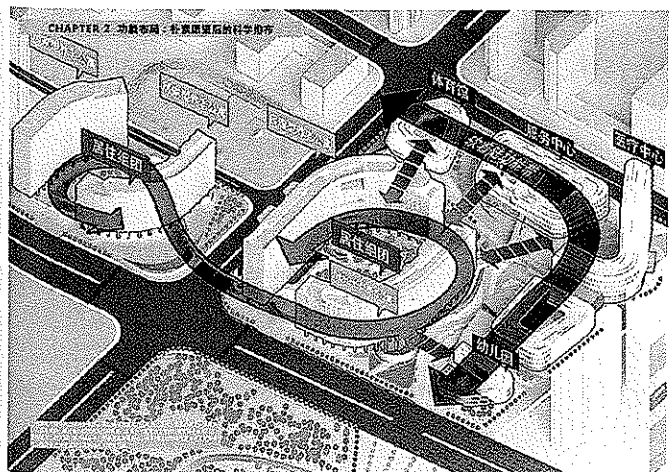

天士力医疗康复大健康研究中心
 Tianshili medical rehabilitation
 health research center

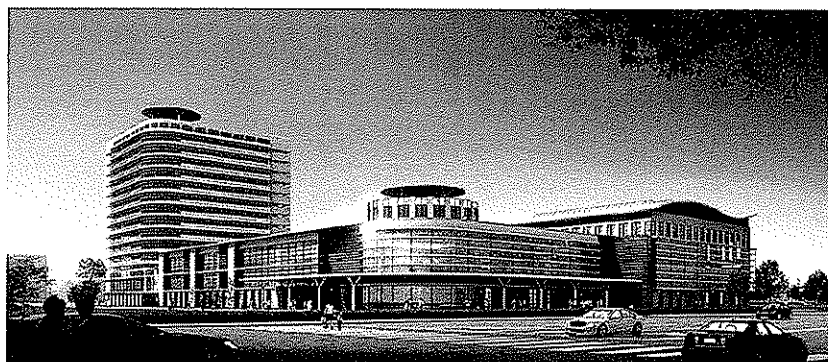

天津西青区生物技术创新中心策划
 Planning of tianjin xiqing district
 biotechnology innovation center

Land area: 26 hectares
 Industrial format: medical industry
 health life

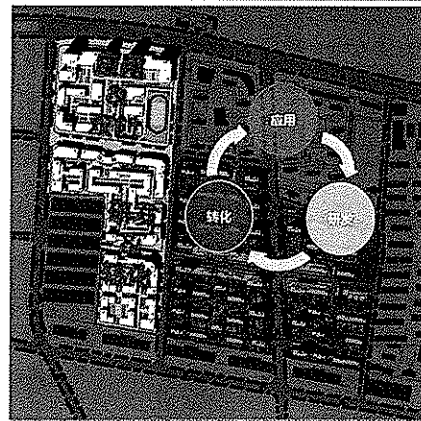
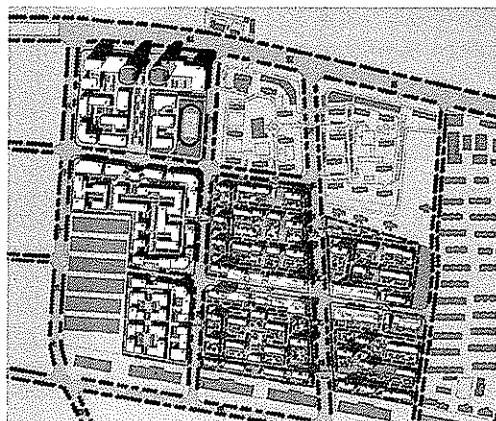
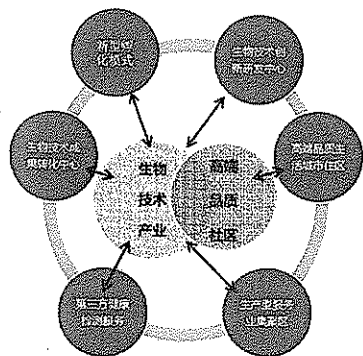

天津万新国际健康产业城策划
Tianjin Wanxin International
Health Industry City Planning

Land area: 138 hectares
Industry format: medical services
Medical industry health life

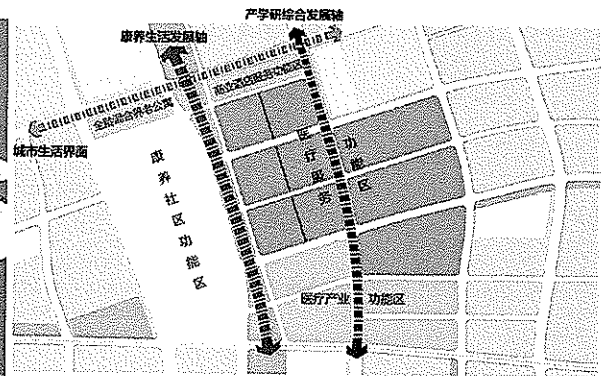
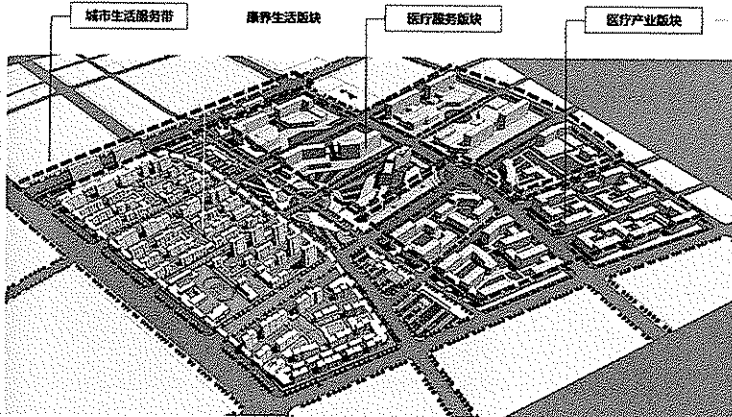
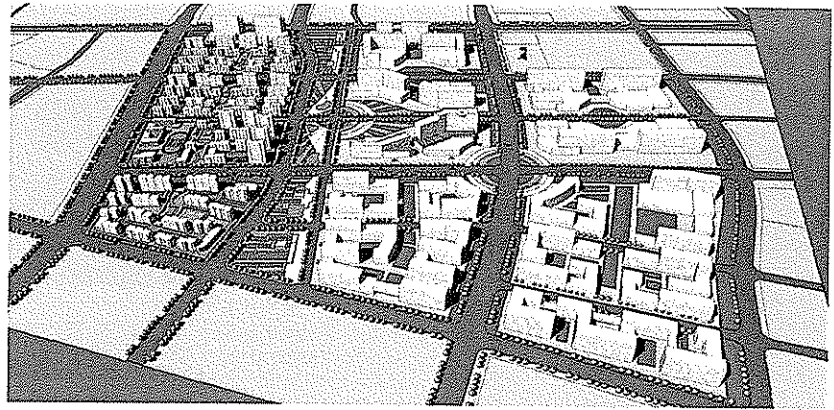

医疗卫生建筑 MEDICAL BUILDINGS



Xinpu Subsidiary Hospital to Zunyi Medical University
Construction Location: Zunyi
Xinpu New District, Guizhou
Structural Form: frame-shear wall
Construction Area: 195,000m²
Beds: 1,500
Date of Design: 2015



Xinpu New District People's Hospital
Construction Location: Zunyi
Xinpu New District, Guizhou
Structural Form: frame-shear wall
Construction Area: 95,000m²
Beds: 500
Date of Design: 2014

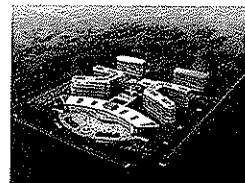

Zunyi Women and Children's Hospital
Construction Location: Zunyi,
Guizhou
Structural Form: frame-shear wall
Construction Area: 113,000m²
Beds: 1,000
Date of Design: 2015



医疗卫生建筑 MEDICAL BUILDINGS

**Tianjin Shiji Dongfang Hospital**

Construction Location: Tianjin
Structural Form: frame-shear wall
Construction Area: 70,000m²
Beds: 600
Grade-III A General Hospital
Date of Design: 2008
Main Functions: healthcare, in-patient service
Grade-III A General Hospital

**Xi'an Mental Health Center**

Construction Location: Xi'an
Structural Form: frame-shear wall
Area: 117,000m²
Construction Area: 67,000m²
Floors: 2-4 floors
Date of Design: 2010
Main Functions: healthcare, in-patient service

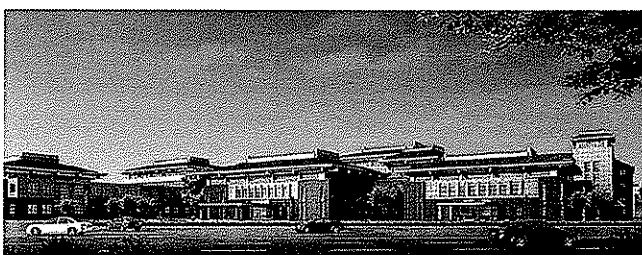
**Xi'an Tuberculosis Hospital**

Construction Location: Xi'an
Structural Form: frame-shear wall structure
Area: 730,00m²
Construction Area: 70,000m²
Floors: 3 floors above ground/4 floors in part
Date of Design: 2010
Main Functions: healthcare, in-patient service

医疗卫生建筑 MEDICAL BUILDINGS

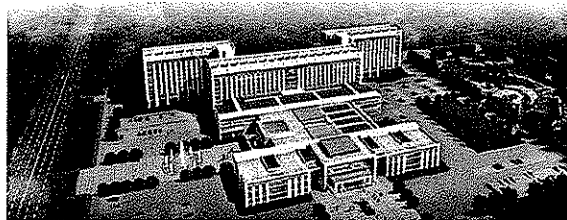
**Ji County People's Hospital**

Construction Location: Tianjin
Structural Form: frame-shear wall
Construction Area: 110,000m²
Beds: 1,000
Floors/Height: 10 floors/47.6m
Date of Design: 2010
Main Functions: healthcare, in-patient service

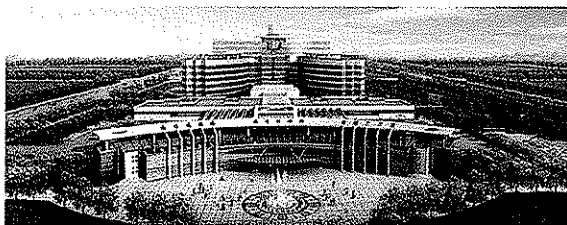
**Dandong New District Hospital**

Construction Location: Tianjin
Structural Form: frame-shear wall Structure
Area: 201,000m²
Construction Area: 193,000m²
Floors/Height: 9 floors/35.5m
Date of Design: 2010
Main Functions: healthcare, in-patient service

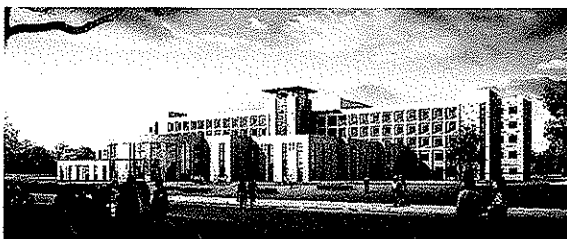
**Ningqiang Tianjin Hospital**

Construction Location: Ningqiang County
Structural Form: frame-shear wall structure
Area: 57,000m²
Construction Area: 34,000m²
Floors/Height: 7 floors/23.95m
Date of Design: 2008
Main Functions: healthcare, in-patient service



Medical architecture all-round service model

An important role in the contemporary medical wisdom is
Chinese every citizen should not be ignored, as the first

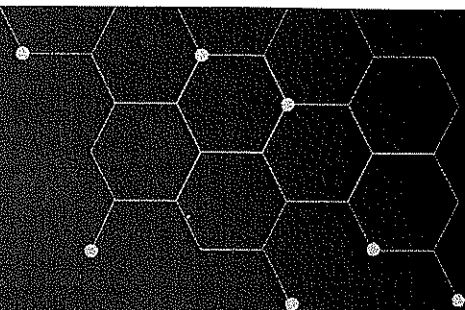
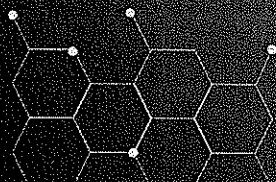
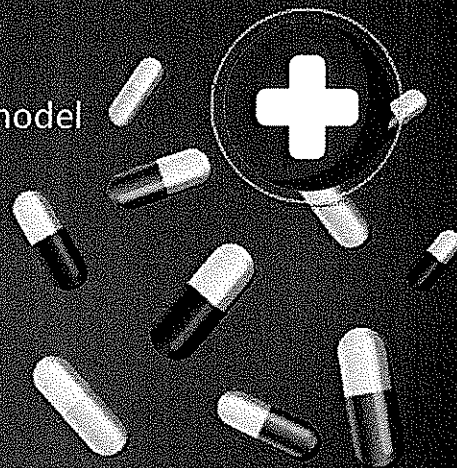

SECTION 5 - ABOUT PEAK INTERNATIONAL



匹克国际贸易(天津)有限公司

PEAK INTERNATIONAL TRADE (TIANJIN) CO., LTD.

38 Dali Road, Heping District, Tianjin, China P.C.: 300050

Tel: 86-22-8988 8088, 27129876/77/78 Fax: 86-22-89886660, 2712 8999

E-Mail: export@peakglobe.com

Company Profile

1. Name of the Bidder: **Peak International Trade (Tianjin) Co. Ltd.**
2. Address of the Bidder: 38 Dali Road, Heping District, Tianjin, China
3. Date of Establishment & Registration: 1992
4. Registered No.: 120000400009909
5. Total Investment: USD30 Million, Registered Capital: USD15 Million
6. Scope of Main Business:
Import & Export, Storing & Transportation, Manufacturing, Consultant Services.
7. Main Bank Reference:
China Merchants Bank Tianjin Branch
Address: 255 Guangdong Road, Hexi District, Tianjin, China
Tel: 86 - 22- 23331801 Fax: 86 - 22 - 23331806
8. Orders/Contracts From United Nations and Other International Organizations:
2016 USD64, 362,331.00 + USD125, 145,873.00 (LTA – Long Term Agreement)
2017 USD58,654,187.00 + USD 87,386,605.00 (LTA – Long Term Agreement)
2018 USD53,171,980.00+ USDUS\$157,047,251.00 (LTA – Long Term Agreement)
9. ISO9001: ISO9001:2015/ISO14001:2015/OHSAS18001:2007 Certificate: Attached
10. Bidder's Reference List: will provide upon Request.

We hereby certify to the best of our knowledge that the foregoing statements are true and correct and all available information and data have been supplied herein, and that we agree to show you documentation proof thereof upon your request.

Peak International Trade (Tianjin) Co., Ltd.

UNGM Register No.: 113512

Peak

匹克国际贸易(天津)有限公司

PEAK INTERNATIONAL TRADE (TIANJIN) CO., LTD.

38 Dali Road, Heping District, Tianjin, China P.C.: 300050

Tel: 86-22-8988 8088, 27129876/77/78 Fax: 86-22-89886660, 2712 8999

E-Mail: export@peakglobe.com

Introduction

PEAK INTERNATIONAL TRADE (TIANJIN) CO., LTD. was founded in 1992 with total investment of USD30 Millions, mainly engages in international trade business and related services in all of world has acquired extensive experiencing in marketing of international trade. The company has established several branches and representative offices both at home and abroad, also set up agencies and distributors in more than 40 overseas countries, thus forming worldwide business network.

The company has wide-ranging business scope, mainly exportation and importation of mechanical/electrical products, tendering and agency business. The company adopts flexible business terms, co-operates with many famous companies and high-tech enterprises in China and has become their overseas agent for developing international market. In the past years, Peak had exported various mechanical and electrical products as well as complete sets of equipment abroad. The company is registered supplier of United Nations System, Government and International Organizations, and won many international tenders funded by UN, World Bank, famous European banks, international aid to developing countries and international organizations. Peak International also provides excellent commercial services and has become the searching window for procuring on behalf of many famous overseas organizations or companies on products make in China.

Supported by over 50 wholly-owned or majority-owned subsidiaries by parent group – Tianjin Sino-Investment Group, Peak International extends services from manufacturing to whole solutions meeting exactly the client's requirements with high efficiency.

The sales and marketing center of Peak International actively engages in marketing planning, sales promotion and after sales servicing for many foreign brand products and has become the sole agent for many international brands in local markets, and high-tech products for domestic customers to meet their demands.

Peak International obtained the Certificate of ISO9001 since December 2006 to provide high-quality services to customers.

ISO 9001: 2015

ISO14001: 2015

OHSAS 18001: 2007



Peak warmly welcomes all friends both at home and abroad to contact and co-operate with us for mutual benefits and prosperity.

Peak

匹克国际贸易(天津)有限公司

PEAK INTERNATIONAL TRADE (TIANJIN) CO., LTD.

38 Dali Road, Heping District, Tianjin, China P.C.: 300050

Tel: 86-22-8988 8088, 27129876/77/78 Fax: 86-22-89886660, 2712 8999

E-Mail: export@peakglobe.com

Basic Information:

Main business scopes:

Imports and exports of mechanical and electrical machinery and equipment, energy engineering equipment, housing & architecture products, water supply & treatment equipment, locomotives and rolling stocks, ships, automobiles, environmental protection equipment, completed plants and other machinery products; Project investment & financing; Technology imports and exports; Bidding; Government procurement; Overseas engineering project contracting; Transportation; Logistic Services; Consulting.

Quality Certificate: ISO9001:2015/ISO14001:2015/OHSAS18001:2007

Guideline: Customer Supremacy, Honest Business, Value Creation and Constant Improvement.

Number of years in the business: 27 years

Number of staff: 87

Member of organizations:

- Vice Chairman of China Chamber of International Commerce (CCOIC) and China Council for the Promotion of International Trade (CCPIT), who are one of the largest chamber of commerce in China.
- Vice Chairman of Commission on Environment and New Energy of China Chamber of International Commerce (CCOIC)
- Director of Pacific Economic Cooperation Council (PECC)
- Director of APEC China Business Council
- Director of G20 China Business Council
- Chairman of Tianjin Foreign Economic & Trade Promotion Association
- Vice Chairman of Shanghai Chamber of International Commerce
- Vice Chairman of Tianjin Chamber of Commerce for Import & Export
- Administrative Vice Chairman of Ningbo Chamber of Commerce

PEAK

PEAK INTERNATIONAL TRADE (TIANJIN) CO., LTD.

ORGANIZATION CHART

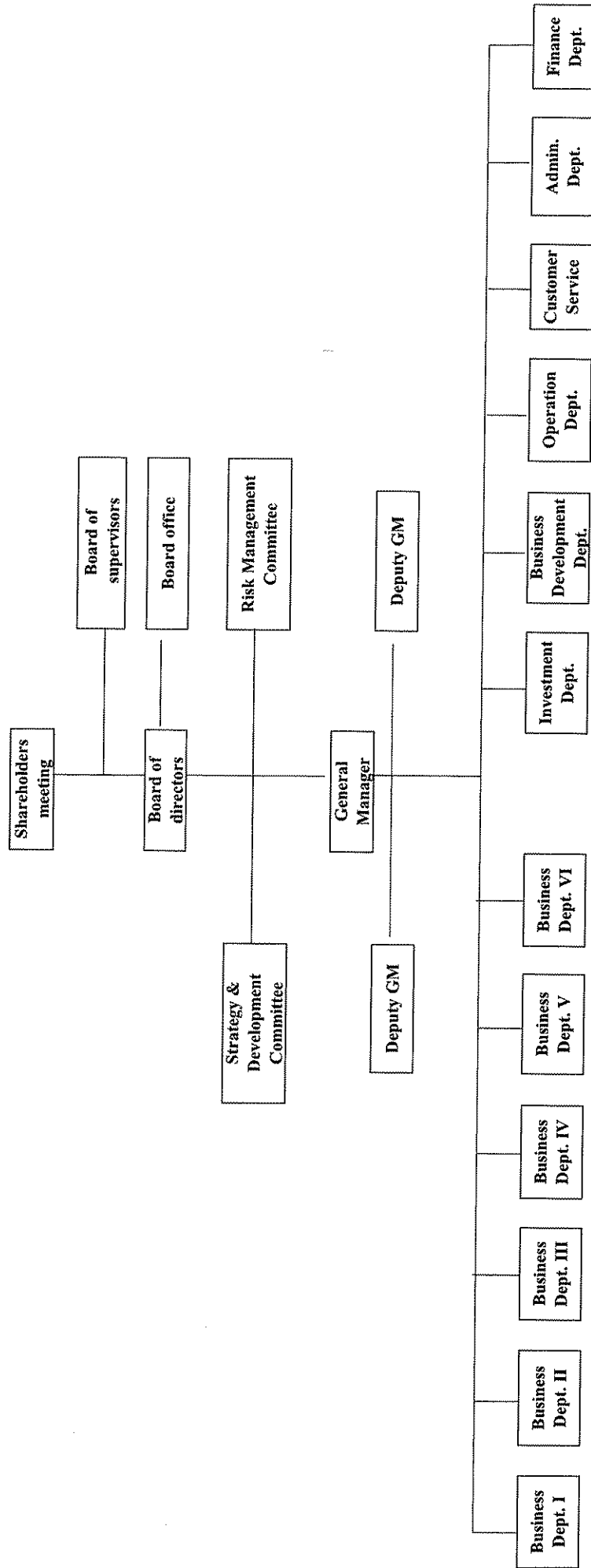

编号: NQ 0598341

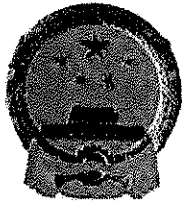

企业法人 营业执照

名称 匹克国际贸易(天津)有限公司
住所 天津港保税区海滨五路31号119室
法定代表人 余弘力
注册资本 壹仟伍佰万美元
实收资本 壹仟伍佰万美元
公司类型 有限责任公司(台港澳与境内合资)
经营范围

国际贸易及相关的委托业务, 代办保税货物仓储服务、简单加工、自有房屋租赁、投资管理, 以上相关咨询服务; 机电产品、五金交电、建筑材料、机电设备、成套设备的批发、零售及进出口(以上商品进出口不涉及国营贸易、进出口配额许可证、出口配额招标、出口许可证等商品, 其他专项规定管理的商品按照国家有关规定办理) ***

注册号: 12000400009909

成立日期: 1992-12-21

股东(发起人)

天津中投投资发展有限公司; 中国香港投资开发集团有限公司

登记机关



2010年05月24日

营业期限 自 1992-12-21
至 2042-12-20

ENTERPRISE CORPORATION BUSINESS LICENSE

(TRANSLATION)

REGISTRATION NO. : 12000400009909
 DATE OF ESTABLISHMENT : DECEMBER 21, 1992
 REGISTRATION AUTHORITY : TIANJIN CITY ADMINISTRATION FOR INDUSTRY & COMMERCE

NAME OF FIRM : PEAK INTERNATIONAL TRADE (TIANJIN) CO., LTD
 LEGAL LOCATION : TIANJIN FREE TRADE ZONE, TIANJIN, CHINA
 PRINCIPAL OFFICER : YU HONGLI
 REGISTERED CAPITAL : USD15,000,000.00
 PAID-UP CAPITAL : USD15,000,000.00
 TYPE OF OWNERSHIP : LIMITED
 SCOPE OF BUSINESS : INTERNATIONAL TRADE AND RELATED BUSINESS, STORING & TRANSPORTATION, MANUFACTURING, INVESTMENT ADMINISTRATION, CONSULTING SERVICES
 SHAREHOLDERS : CHINA NATIONAL INVESTMENT CO., LTD.
 : TIANJIN SINO-INVESTMENT DEVELOPMENT CO., LTD.
 OPERATION PERIOD : FROM DECEMBER 21, 1992 TO DECEMBER 20, 2042

Certificate of Registration



The Governing Board of
Q.A. International Certification Limited
hereby grants to:

Peak International Trade (Tianjin) Co., Ltd.

Unified Social Credit Code: 91120116600509249B
Registration No.: QAIC / CN / 170549

(hereinafter called the Registered Company) the right to be listed in the Directory of Registered Companies in respect of the services listed below. These services shall be offered by the Registered Company at or from only the active business address given below in accordance with the quality management system in compliance with ISO 9001:2015.

Business License Address:

**Room 630, 6/F, Building 1, No.40, Tianbao Avenue,
(Tianjin Port Bonded Area) Tianjin Pilot Free Trade Zone, P.R.China**

Active Business Address to which this Certificate is registered:

No.38, Dali Road, Heping District, Tianjin, P.R.China

Approved Scope to which this Certificate refers:

The Provision of International Trade (Domestic and International Bidding and Procurement), Various Goods and Technology Import & Export Service.
(Please note that the above scope represents the certified activity of the named organization and as such, the organization may undertake additional activities that are not covered under this certification).

Signed for and on behalf of the Board

CHIEF EXECUTIVE

SCHEME MANAGER

Certificate Issue Date : 28th June 2020 - Certificate Renewal Before : 27th June 2021
Date of Initial Registration : 26th July 2017 - Re-Certification Before : 27th June 2023

This Certificate of Registration is granted subject to the Regulations approved by the Board.
The information of this certificate can be searched on the website of CNCA (www.cnca.gov.cn).
The certified organization should apply for regular audit to maintain its qualification.

QA INTERNATIONAL

Q.A. International Certification Ltd.
Dudley Court
Dudley Road
Darlington
United Kingdom
DL1 4GG

Tel: +44 (0)1325 884272
Fax: +44 (0)1325 480980
www.qai.co.uk

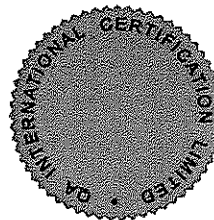

The use of the UKAS logo indicates
recognition in respect of those activities covered
by the accreditation certificate number 1616

Certificate of Registration



The Governing Board of
Q.A. International Certification Limited
hereby grants to:

Peak International Trade (Tianjin) Co., Ltd.

Unified Social Credit Code: 91120116600509249B
Registration No.: QAIC / CN / 170312

(hereinafter called the Registered Company) the right to be listed in the Directory of Registered Companies in respect of the services listed below. These services shall be offered by the Registered Company at or from only the active business address given below in accordance with the environmental management system in compliance with ISO 14001:2015.

Business License Address:

**Room 630, 6/F, Building 1, No.40, Tianbao Avenue,
(Tianjin Port Bonded Area) Tianjin Pilot Free Trade Zone, P.R. China**

Active Business Address to which this Certificate is registered:

No.38, Dali Road, Heping District, Tianjin, P.R. China

Approved Scope to which this Certificate refers:

**The Provision of International Trade (Domestic and International Bidding and Procurement),
Various Goods and Technology Import & Export Service
and Management of Related Environmental Aspects.**

(Please note that the above scope represents the certified activity of the named organization and as such, the organization may undertake additional activities that are not covered under this certification).

Signed for and on behalf of the Board

CHIEF EXECUTIVE

SCHEME MANAGER

Certificate Issue Date : 28th June 2020 - Certificate Renewal Before : 27th June 2021
Date of Initial Registration : 22nd May 2017 - Re-Certification Before : 27th June 2021

This Certificate of Registration is granted subject to the Regulations approved by the Board.
The information of this certificate can be searched on the website of CNCA (www.cnca.gov.cn).
The certified organization should apply for regular audit to maintain its qualification.

QA INTERNATIONAL

Q.A. International Certification Ltd.
Dudley Court
Dudley Road
Darlington
United Kingdom
DL1 4CG

Tel: +44 (0)1325 984272
Fax: +44 (0)1325 480980
www.qai.co.uk

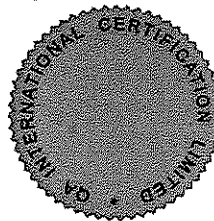

The use of the Accreditation Mark indicates accreditation in respect of those activities covered by the accrediting certificate number 1510.

Certificate of Registration



The Governing Board of
Q.A. International Certification Limited
hereby grants to:

Peak International Trade (Tianjin) Co., Ltd.

Unified Social Credit Code: 91120116600509249B
Registration No.: QAIC / CN / 179038

(hereinafter called the Registered Company) the right to be listed in the Directory of Registered Companies in respect of the services listed below. These services shall be offered by the Registered Company at or from only the active business address given below in accordance with the health & safety management system in compliance with ISO 45001:2018.

Business License Address:

**Room 630, 6/F, Building 1, No.40, Tianbao Avenue,
(Tianjin Port Bonded Area) Tianjin Pilot Free Trade Zone, P.R. China**

Active Business Address to which this Certificate is registered:

No.38, Dali Road, Heping District, Tianjin, P.R. China

Approved Scope to which this Certificate refers:

**The Provision of International Trade (Domestic and International Bidding and Procurement),
Various Goods and Technology Import & Export Service and Management of
Related Occupational Health and Safety Aspects.**

(Please note that the above scope represents the certified activity of the named organization and as such, the organization may undertake additional activities that are not covered under this certification).

Signed for and on behalf of the Board

CHIEF EXECUTIVE

SCHEME MANAGER

Certificate Issue Date : 28th June 2020 - Certificate Renewal Before : 27th June 2021
Date of Initial Registration : 27th May 2017 - Re-Certification Before : 27th June 2021

This Certificate of Registration is granted subject to the Regulations approved by the Board.
The information of this certificate can be searched on the website of CNCA (www.cnca.gov.cn).
The certified organization should apply for regular audit to maintain its qualification.

QA INTERNATIONAL

QA International Certification Ltd.
Dudley Court
Dudley Road
Darlington
United Kingdom
DL1 4CG

Tel: +44 (0)1325 354272
Fax: +44 (0)1325 480980
www.qai.co.uk



Environmental Policy of Peak International Trade (Tianjin) Co., Ltd.

1. Corporate priority

To recognize environmental management as among the highest corporate priorities and as a key determinant to sustainable development; to establish policies, programs and practices for conducting operations in an environmentally sound manner.

2. Integrated management

To integrate these policies, programs and practices fully into each business as an essential element of management in all its functions.

3. Process of improvement

To continue to improve corporate policies, programs and environmental performance, taking into account technical developments, scientific understanding, consumer needs and community expectations, with legal regulations as a starting point; and to apply the same environmental criteria internationally.

4. Employee education

To educate, train and motivate employees to conduct their activities in an environmentally responsible manner.

5. Prior assessment

To assess environmental impacts before starting a new activity or project and before decommissioning a facility or leaving a site.

6. Products and services

To develop and provide products or services that have no undue environmental impact and are safe in their intended use, that are efficient in their consumption of energy and natural resources, and that can be recycled, reused or disposed of safely.

7. Customer advice

To advise and, where relevant, to educate customers, distributors and the public in the safe use, transportation, storage and disposal of products provided; and to apply similar considerations to the provision of services.

8. Facilities and operations

To develop, design and operate facilities and conduct activities taking into consideration the efficient use of renewable resources, the minimization of adverse environmental impact and waste generation and the safe and responsible disposal of residual wastes.

9. Research

To conduct or support research on the environmental impacts of raw materials, products, processes, emissions and wastes associated with the enterprise and on the means of minimizing such adverse impacts.

Environmental Policy of Peak International Trade (Tianjin) Co., Ltd.

10. Precautionary approach

To modify the manufacture, marketing or use of products or services or the conduct of activities, consistent with scientific and technical understanding, to prevent serious or irreversible environmental degradation.

11. Contractors and suppliers

To promote the adoption of these principles by contractors acting on behalf of the enterprise, encouraging and, where appropriate, requiring improvements in their practices to make them consistent with those of the enterprise; and to encourage the wider adoption of these principles by suppliers.

12. Emergency preparedness

To develop and maintain, where significant hazards exist, emergency preparedness plans in conjunction with the emergency services, relevant authorities and the local community, recognizing potential trans-boundary impacts.

13. Transfer of technology

To contribute to the transfer of environmentally sound technology and management methods throughout the industrial and public sectors.

14. Contributing to the common effort

To contribute to the development of public policy and to business, governmental and intergovernmental programs, and educational initiatives that will enhance environmental awareness and protection.

15. Openness to concerns

To foster openness and dialogue with employees and the public, anticipating and responding to their concerns about the potential hazards and impacts of operations, products, wastes or services, including those of trans-boundary or global significance.

16. Compliance and reporting

To measure environmental performance; to conduct regular environmental audits and assessments of compliance with company requirements, legal requirements and these principles; and periodically to provide appropriate information to the Board of Directors, shareholders, employees, the authorities and the public.



天津津永會計師事務所(普通合伙)

TIANJIN JINYONG CERTIFIED PUBLIC ACCOUNTANTS

Auditor's Report (translation)

Jinyong Audit (2020) No. 042

Peak International Trade (Tianjin) Co., Ltd.:

1. Audit Opinion

We have audited the financial statements of Peak International Trade (Tianjin) Co., Ltd., including the balance sheets as of December 31st, 2019; income statements of 2019, cash flow statements, statement of changes in owners' equity and notes to financial statements.

In our opinion, the attached financial statements of Peak International Trade (Tianjin) Co., Ltd. are prepared in accordance with the Accounting Standard for Business Enterprises in all material respects. They fairly and honestly represent Peak International Trade (Tianjin) Co., Ltd.'s financial position as of December 31, 2019 and the operation results and the cash flow for the year.

2. Foundation to form the audit opinion

We carried out the audit in accordance with the rules of China Certified Public Accountant's auditing standards. Our responsibilities under these standards are further elaborated in the Certified Public Accountant part of the audit of financial statements. We are confident that the obtained audit evidence is sufficient and appropriate, which forms a firm basis for giving our audit opinion.

According to the Certified Public Accountant Code of ethics, we are independent of Peak International Trade (Tianjin) CO., Ltd. and performed other duties in the area of professional ethics.

3. Other information

The management team of Peak International Trade (Tianjin) Co., Ltd. (Here after called "the management team") will responsible for other information. The other information refers to the information contains in the report of 2019, but not including the financial statements and our audit report.

Our audit opinion about the financial statement not refers to any other information. We also not provide any Conclusion of identification for other information.

In conjunction with our audit of financial statement, our responsibility is to read other information, during of which we will consider whether these is any discordance or misreport with the financial statement or conditions we have noticed during the audit process. Base on our fulfilled work, we will post the facts in case we confirmed the information is majorly misreported. From this respect, we have nothing to post.



天津津永會計師事務所(普通合伙)

TIANJIN JINYONG CERTIFIED PUBLIC ACCOUNTANTS

4. Management Responsibility for Financial Reports

The management team is responsible to prepare and fairly present the financial statements in accordance to the rules of Accounting Standard of the company, to achieve a fair reflection, and design, implement and maintain the necessary internal controls, So that the financial statements are free from material misstatement due to fraud or error.

In preparing the financial statements, management team is responsible for assessing Peak International Trade (Tianjin) Co., Ltd.'s ability to sustain business, disclose the events(if applicable) related to the sustain business, and assume sustain business, Unless management team plans to liquidate the Peak International Trade (Tianjin) Co., Ltd., cease operations or have no realistic alternative.

The management team is response for the Supervising of Peak International Trade (Tianjin) Co., Ltd.'s financial reporting process.

5. Responsibility of Certified Public Accountants

Our objective is to obtain reasonable assurance as to whether the financial statements as a whole are free from material misstatement, whether due to fraud or error, and to issue an audit report with an assurance audit opinion. Reasonable assurance is a high level of assurance, but an audit conducted in accordance with auditing standards does not guarantee that significant misstatements will be found. Misstatements may be the result of fraud or error and are generally considered majority misreport if they are reasonably expected to affect, individually or collectively, the economic decisions made by the users of the financial statements on the basis of the financial statements.

We exercise professional judgment and maintain professional suspicion in the conduct of our audits During of which we will do the following:

- 1) Identify and assess the risks of material misstatement of the financial statements resulting from fraud or error, design and implement audit procedures to address these risks, and obtain sufficient and appropriate audit evidence to form the basis of an audit opinion. As fraud may be the result of collusion, forgery, intentional omission, misrepresentation or override of internal controls, the risk of failure to detect material misstatement due to fraud is higher than the risk of failure to detect material misstatement due to error
- 2) To understand of audit-related internal controls to design appropriate audit procedures.
- 3) To evaluate the appropriateness of accounting policies chosen by management and the reasonableness of accounting estimates and related disclosures.
- 4) Draw conclusions about the appropriateness of management's assumption of sustain business. At the same time, based on the audit evidence obtained, conclusions are drawn as to whether there are significant uncertainties in matters or circumstances that may give rise to significant doubts about a company's ability to continue operations. If we conclude that there is significant uncertainty, the auditing standards require that we draw the attention of the users of the statements to the relevant disclosures in the financial statements in our audit reports. If the disclosure is not sufficient, we should express a non-unqualified opinion. Our conclusions are based on the



天津津永會計師事務所 (普通合伙)

TIANJIN JINYONG CERTIFIED PUBLIC ACCOUNTANTS

information available as the date of the audit report. However, future events or circumstances may render the company unviable.

- 5) Evaluate the overall presentation, structure, and content of financial statements and assess whether they fairly reflect transactions and events.

We communicated with the management on the planned audit scope, schedule and significant audit findings, including the internal control deficiencies that we have identified during the audit that are of concern.

Tianjin Jinyong Certified Public Accountants
(stamp)

Tianjin, China

Chinese Certified Public Accountants
Luan Ling
(signature and stamp)

Chinese Certified Public Accountants
Han Yue
(signature and stamp)

Date: April 14, 2020

Balance Sheet (translation)

As of December 31, 2019

Company: PEAK INTERNATIONAL TRADE (TIANJIN) CO.,LTD.

UNIT: RMB

ITEMS	Line No	CLOSING BALANCE	ITEM	Line No	CLOSING BALANCE
current assets:	1	—	current liabilities	54	—
Monetary Fund	2	32,512,444.38	Short-term loans	55	42,000,000.00
Financial assets at fair value through profit or loss	3		Financial liabilities at fair value through profit or loss	56	
Derivative financial assets	4		Derivative financial liabilities	57	
Notes receivable/Accounts receivable	5	61,855,312.00	Notes payable/Accounts payable	58	34,546,397.12
Accounts prepaid	6	114,662,220.59	Advances from customers	59	1,128,516.23
Other receivables	7	4,849,158.17	Employee Benefits Payable	60	127,837.67
Inventories	8	1,754,519.68	where: Accrued payroll	61	
where: Raw material	9		Taxes and surcharges payable	62	379,319.29
Goods on hand (finished goods)	10		where: Taxes payable	63	379,319.29
Assets classified as held for trading	11		Dividends Payable	64	
Allowance receivable within one year	12		Other payables	65	17,784,783.95
Other current assets	13		non-current liabilities within one year	66	
Total current assets	14	215,633,654.82	Other current liabilities	67	16,026,834.84
Non-current assets:	15		Total current liabilities	68	111,993,689.10
Available-for-sale financial assets	16		long term liabilities	69	
Held-to-maturity investments	17		Long-term loans payable	70	
Long-term receivables	18		Bonds payable	71	
Long-term equity investments	19		preferred stock	72	
Investment Properties	20		Perpetual debt	73	
Net for Investment Properties	21		Long-term payable	74	
Fixed assets-cost	22	15,762,598.34	estimated liabilities	75	
Less: Accumulated Depreciation	23	7,692,107.16	deferred income	76	
Fixed assets-net value	24	8,070,491.18	Deferred income tax liability	77	
Less: Impairment of fixed assets	25		Other non-current Liabilities	78	
Net value of fixed assets	26	8,070,491.18	Total non-current liabilities	79	
Construction in Progress	27		Total liabilities	80	111,993,689.10
Bearer biological assets	28		Owners' equity (or Stockholders' equity):	81	
Oil and gas assets	29		Paid-in capital (Stock capital)	82	103,929,070.00
Intangible assets	30	231,408.39	where: State-owned legal entity capital	83	
Development costs	31		Legal person's capital	84	103,929,070.00
Goodwill	32		Private capital	85	
Long-term prepaid expenses	33	85,835.40	Foreign capital	86	
Deferred tax asset	34		Capital surplus	87	
Other non-current assets	35		Less: Treasury stock	88	
Total non-current assets	36	8,387,734.97	earned surplus	89	2,881,549.51
	37		Where: Statutory Provident Fund	90	
	38		Free Reserve Fund	91	
	39		Retained earnings	92	5,217,081.18
	40		Total shareholder's equity	93	112,027,700.69
Total Assets	41	224,021,389.79	Total Liabilities & Equity	94	224,021,389.79

Income Statement (translation)

As of December 31, 2019

Company: PEAK INTERNATIONAL TRADE (TIANJIN) CO., LTD.

UNIT: RMB

ITEM	Line No.	CURRENT YEAR
一、 Main operating revenue	1	193,804,606.71
Where: Main business revenue	2	193,804,606.71
Other business revenue	3	
二、 Main operating cost	4	187,744,609.44
Where: Cost of sales	5	164,113,362.32
Other cost	6	
Sales tax	7	200,449.42
Selling cost	8	14,590,977.85
Administrative cost	9	9,007,815.68
Where: R&D Cost	10	
Financial expenses	11	-167,995.83
Including: Interest expenses	12	1,581,098.04
minus interest income	13	117,596.11
Exchange losses(minus exchange gains)		-2,245,724.78
Asset Impairment Losses	14	
Add: Profit from other operations	15	
Income from investment	16	6,465.21
Where: Return on investment in joint ventures and joint ventures	17	
Profit arising from changes in fair value	18	
Income from disposal of assets	19	
三、 Operating profit	20	6,066,462.48
Add: Non-operating income	21	929,734.84
where: Gains on disposal of non-current assets	22	
Gains on exchange of non-monetary assets	23	
Government Grants	24	
Gains on debt restructuring	25	
Less: Non-operating expenses	26	13,429.50
where: losses on disposing of non-current assets	27	
Losses on exchange of non-monetary assets	28	
Losses on debt restructuring	29	
四、 Total profit	30	6,982,767.82
Less: Income tax	31	1,745,691.96
五、 Net profit	33	5,237,075.86

Cash Flow Statement (translation)

As of December 31, 2019

Company: PEAK INTERNATIONAL TRADE (TIANJIN) CO., LTD.

UNIT: RMB

ITEM	Number	Cumulative figures for the year
一、 CASH FLOWS FROM OPERATING ACTIVITIES:	1	—
Cash received from sale of goods or rendering of services	2	203,177,403.96
Refund of tax and levies	3	24,244,214.71
Other cash received relating to operating activities	4	52,780,515.44
Sub-total of cash inflows	5	280,202,134.11
Cash paid for goods and services	6	289,292,397.65
Cash paid to and on behalf of employees	7	10,573,169.93
Payments of all types of taxes	8	2,860,573.79
Other cash paid relating to operating activities	9	17,108,712.43
Sub-total of cash outflows	10	319,834,853.80
Net cash flows from operating activities	11	-39,632,719.69
二、 CASH FLOWS FROM INVESTING ACTIVITIES:	12	0.00
Cash received from disposal of investments	13	3,800,000.00
Cash received from returns on investments	14	6,465.21
NetCashReceivedFromDisposalOfFixedAssets,IntangibleAssets&OtherLong-termAssets	15	0.00
Net cash received from disposal of subsidiaries and other business units	16	0.00
Cash received relating to other investing activities	17	0.00
Sub-total of cash inflows from investment activities	18	3,806,465.21
Cash paid to acquire fixed assets,intangible assets & other long-term assets	19	0.00
Cash paid to acquire investments	20	3,800,000.00
Other cash payments relating to investing activities	21	0.00
Cash paid to acquire investments	22	0.00
Sub-total of cash outflows	23	3,800,000.00
Net cash flows from investing activities	24	6,465.21
三、 CASH FLOWS FROM FINANCING ACTIVITIES:	25	0.00
Cash received from capital contribution	26	0.00
where: Cash received from capital contributions by minority shareholders of subsidiaries	27	0.00
Cash received from borrowings	28	62,181,888.87
Other cash received relating to financing activities	29	0.00
Sub-total of cash inflows	30	62,181,888.87
Cash repayments of amounts borrowed	31	74,370,194.18
Cash payments for interest expenses and distribution of dividends or profit	32	1,261,403.94
where: Dividends and profits paid by subsidiaries to minority shareholders	33	0.00
Other cash payments relating to financing activities	34	144,443.12
Sub-total of cash outflows	35	75,776,041.24
Net cash flows from financing activities	36	-13,594,152.37
四、 EFFECT OF FOREIGN EXCHANGE RATE CHANGES ON CASH	37	3,059,261.76
五、 NET INCREASE/(DECREASE) IN CASH AND CASH	38	-50,161,145.09
ADD:Cash and cash equivalent balance at the beginning of the period	39	82,673,589.47
六、 Balance of cash and cash equivalents at the end of the period	40	32,512,444.38



天津津永會計師事務所(普通合伙)

TIANJIN JINYONG CERTIFIED PUBLIC ACCOUNTANTS

审计报告

津永审字(2020)第042号

匹克国际贸易(天津)有限公司:

一、审计意见

我们审计了匹克国际贸易(天津)有限公司财务报表,包括2019年12月31日的资产负债表,2019年度的利润表、现金流量表以及所有者权益变动表。

我们认为,后附的匹克国际贸易(天津)有限公司的财务报表在所有重大方面按照企业会计准则的规定编制,公允反映了匹克国际贸易(天津)有限公司2019年12月31日的财务状况以及2019年度的经营成果和现金流量。

二、形成审计意见的基础

我们按照中国注册会计师审计准则的规定执行了审计工作。审计报告的“注册会计师对财务报表审计的责任”部分进一步阐述了我们在这些准则下的责任。我们相信,我们获取的审计证据是充分、适当的,为发表审计意见提供了基础。

按照中国注册会计师职业道德守则,我们独立于匹克国际贸易(天津)有限公司,并履行了职业道德方面的其他责任。

三、其他信息

匹克国际贸易(天津)有限公司管理层(以下简称管理层)对其他信息负责。其他信息包括2019年度报告中涵盖的信息,但不包括财务报表和我们的审计报告。

我们对财务报表发表的审计意见不涵盖其他信息,我们也不对其他信息发表任何形式的鉴证结论。

结合我们对财务报表的审计,我们的责任是阅读其他信息,在此过程中,考虑其他信息是否与财务报表或我们在审计过程中了解到的情况存在重大不一致或者似乎存在重大错报。基于我们已经执行的工作,如果我们确定其他信息存在重大错报,我们应当



天津津永會計師事務所(普通合伙)

TIANJIN JINYONG CERTIFIED PUBLIC ACCOUNTANTS

报告该事实。在这方面，我们无任何事项需要报告。

四、管理层和治理层对财务报表的责任

管理层负责按照企业会计准则的规定编制财务报表，使其实现公允反映，并设计、执行和维护必要的内部控制，以使财务报表不存在由于舞弊或错误导致的重大错报。

在编制财务报表时，管理层负责评估匹克国际贸易（天津）有限公司的持续经营能力，披露与持续经营相关的事项（如适用），并运用持续经营假设，除非管理层计划清算匹克国际贸易（天津）有限公司、停止营运或别无其他现实的选择。

治理层负责监督匹克国际贸易（天津）有限公司的财务报告过程。

五、注册会计师对财务报表审计的责任

我们的目标是对财务报表整体是否不存在由于舞弊或错误导致的重大错报获取合理保证，并出具包含审计意见的审计报告。合理保证是高水平的保证，但按照审计准则执行的审计并不能保证一定会发现存在的重大错报。错报可能由于舞弊或错误导致，如果合理预期错报单独或汇总起来可能影响财务报表使用者依据财务报表作出的经济决策，则通常认为错报是重大的。

在按照审计准则执行审计的过程中，我们运用职业判断，并保持职业怀疑。同时，我们也执行以下工作：

1、识别和评估由于舞弊或错误导致的财务报表重大错报风险，设计和实施审计程序以应对这些风险，并获取充分、适当的审计证据，作为发表审计意见的基础。由于舞弊可能涉及串通、伪造、故意遗漏、虚假陈述或凌驾于内部控制之上，未能发现由于舞弊导致的重大错报的风险高于未能发现由于错误导致的重大错报的风险。

2、了解与审计相关的内部控制，以设计恰当的审计程序。

3、评价管理层选用会计政策的恰当性和作出会计估计及相关披露的合理性。

4、对管理层使用持续经营假设的恰当性得出结论。同时，根据获取的审计证据，就可能对匹克国际贸易（天津）有限公司持续经营能力产生重大疑虑的事项或情况是否存在重大不确定性得出结论。如果我们得出结论认为存在重大不确定性，审计准则要求我们在审计报告中提请报表使用者注意财务报表中的相关披露；如果披露不充分，我



天津津永會計師事務所(普通合伙)

TIANJIN JINYONG CERTIFIED PUBLIC ACCOUNTANTS

们应当发表非无保留意见。我们的结论基于截至审计报告日可获得的信息。然而，未来的事项或情况可能导致匹克国际贸易(天津)有限公司不能持续经营。

5、评价财务报表的总体列报、结构和内容，并评价财务报表是否公允反映交易和事项。

我们与治理层就计划的审计范围、时间安排和重大审计发现等事项进行沟通，包括沟通我们在审计中识别出的值得关注的内部控制缺陷。

天津津永会计师事务所(普通合伙)



中国注册会计师:



中国注册会计师:



2020年04月14日

资产负债表

2019年12月31日

单位: 魁克国际贸易(天津)有限公司

金额单位: 元

项 目	行次	期末余额	期初余额	项 目	行次	期末余额	期初余额
流动资产:	1	—	—	流动负债:	54	—	—
货币资金	2	32,512,444.38	82,673,589.47	短期借款	55	42,000,000.00	7,370,000.00
以公允价值计量且其变动计入当期损益的金融资产	3			以公允价值计量且其变动计入当期损益的金融负债	56		
衍生金融资产	4			衍生金融负债	57		
应收票据及应收账款	5	61,855,312.00	45,093,803.34	应付票据及应付账款	58	34,546,397.12	73,552,610.39
预付款项	6	114,662,220.59	57,549,841.79	预收款项	59	1,128,516.23	
其他应收款	7	4,849,158.17	6,250,312.04	应付职工薪酬	60	127,837.67	
存货	8	1,754,519.68	4,775,556.63	其中: 应付工资	61		
其中: 原材料	9			应交税费	62	379,319.29	826,256.17
库存商品(产成品)	10			其中: 应交税金	63	379,319.29	757,746.35
持有待售资产	11			持有待售负债	64		
一年内到期的非流动资产	12			其他应付款	65	17,784,783.95	16,769,507.95
其他流动资产	13			一年内到期的非流动负债	66		
流动资产合计	14	215,633,654.82	196,343,103.27	其他流动负债	67	16,026,834.84	
非流动资产:	15			流动负债合计	68	111,993,689.10	98,518,374.51
可供出售金融资产	16			非流动负债:	69		
持有至到期投资	17			长期借款	70		
长期应收款	18			应付债券	71		
长期股权投资	19			其中: 优先股	72		
投资性房地产	20			永续债	73		
投资性房地产净额	21			长期应付款	74		
固定资产原价	22	15,762,598.34	15,762,598.34	预计负债	75		
减: 累计折旧	23	7,692,107.16	6,762,303.76	递延收益	76		
固定资产净值	24	8,070,491.18	9,000,294.58	递延所得税负债	77		
减: 固定资产减值准备	25			其他非流动负债	78		
固定资产净额	26	8,070,491.18	9,000,294.58	非流动负债合计	79	—	—
在建工程	27			负债合计	80	111,993,689.10	98,518,374.51
生产性生物资产	28			所有者权益(或股东权益):	81		
油气资产	29			实收资本(股本)	82	103,929,070.00	103,929,070.00
无形资产	30	231,408.39	0.00	其中: 国有资本	83		
开发支出	31			法人资本	84	103,929,070.00	103,929,070.00
商誉	32			个人资本	85		
长期待摊费用	33	85,835.40	477,607.56	外商资本	86		
递延所得税资产	34			资本公积	87		
其他非流动资产	35			减: 库存股	88		
非流动资产合计	36	8,387,734.97	9,477,902.14	盈余公积	89	2,881,549.51	2,881,549.51
	37			其中: 法定公积金	90		
	38			任意公积金	91		
	39			未分配利润	92	5,217,081.18	492,011.39
	40			所有者权益合计	93	112,027,700.69	107,302,630.90
资产总计	41	224,021,389.79	205,821,005.41	负债和所有者权益总计	94	224,021,389.79	205,821,005.41

利润表

2019年度

单位：匹克国际贸易（天津）有限公司

金额单位：元

项 目	行次	本期金额	上期金额
一、营业总收入	1	193,804,606.71	197,236,628.24
其中：主营业务收入	2	193,804,606.71	197,236,628.24
其他业务收入	3		
二、营业总成本	4	187,744,609.44	187,071,854.31
其中：主营业务成本	5	164,113,362.32	174,199,534.37
其他业务成本	6		
营业税金及附加	7	200,449.42	280,371.27
销售费用	8	14,590,977.85	9,408,888.28
管理费用	9	9,007,815.68	5,797,250.50
其中：研发费用	10		
财务费用	11	-167,995.83	-2,614,190.11
其中：利息支出	12	1,581,098.04	6,939,560.25
利息收入	13	117,596.11	969,499.62
汇兑净损失（净收益以“-”号填列）		-2,245,724.78	-9,061,166.51
资产减值损失	14		
加：其他收益	15		
投资收益（损失以“-”号填列）	16	6,465.21	
其中：对联营企业和合营企业的投资收益	17		
公允价值变动收益（损失以“-”号填列）	18		
资产处置收益（损失以“-”号填列）	19		
三、营业利润（亏损以“-”号填列）	20	6,066,462.48	10,164,773.93
加：营业外收入	21	929,734.84	143,910.40
其中：非流动资产处置利得	22		
非货币性资产交换利得	23		
政府补助	24		
债务重组利得	25		
减：营业外支出	26	13,429.50	39,782.28
其中：非流动资产处置损失	27		
非货币性资产交换损失	28		
债务重组损失	29		
四、利润总额（亏损总额以“-”号填列）	30	6,982,767.82	10,268,902.05
减：所得税费用	31	1,745,691.96	2,567,225.51
五、净利润（净亏损以“-”号填列）	33	5,237,075.86	7,701,676.54

现金流量表

2019年度

单位: 匹克国际贸易(天津)有限公司

金额单位: 元

项 目	行次	本年累计数	上年累计数
一、经营活动产生的现金流量:	1	---	---
销售商品、提供劳务收到的现金	2	203,177,403.96	325,397,837.91
收到的税费返还	3	24,244,214.71	16,416,639.27
收到其他与经营活动有关的现金	4	52,780,515.44	12,323,396.10
经营活动现金流入小计	5	280,202,134.11	354,137,873.28
购买商品、接收劳务支付的现金	6	289,292,397.65	274,505,834.60
支付给职工以及为职工支付的现金	7	10,573,169.93	8,207,389.03
支付的各项税费	8	2,860,573.79	2,818,166.75
支付其他与经营活动有关的现金	9	17,108,712.43	59,078,427.76
经营活动现金流出小计	10	319,834,853.80	344,609,818.14
经营活动产生的现金流量净额	11	-39,632,719.69	9,528,055.14
二、投资活动产生的现金流量:	12	0.00	---
收回投资收到的现金	13	3,800,000.00	158,208,504.06
取得投资收益收到的现金	14	6,465.21	1,197,716.70
处置固定资产、无形资产和其他长期资产所收回的现金净额	15	0.00	
处置子公司及其他营业单位收回的现金净额	16	0.00	
收到其他与投资活动有关的现金	17	0.00	
投资活动现金流入小计	18	3,806,465.21	159,406,220.76
购建固定资产、无形资产和其他长期资产所支付的现金	19	0.00	118,920.00
投资支付的现金	20	3,800,000.00	158,180,000.00
取得子公司及其他营业单位支付的现金净额	21	0.00	
支付其他与投资活动有关的现金	22	0.00	
投资活动现金流出小计	23	3,800,000.00	158,298,920.00
投资活动产生的现金流量净额	24	6,465.21	1,107,300.76
三、筹资活动产生的现金流量:	25	0.00	---
吸收投资收到的现金	26	0.00	
其中: 子公司吸收少数股东投资收到的现金	27	0.00	
取得借款所收到的现金	28	62,181,888.87	14,991,841.22
收到其他与筹资活动有关的现金	29	0.00	
筹资活动现金流入小计	30	62,181,888.87	14,991,841.22
偿还债务所支付的现金	31	74,370,194.18	73,624,875.80
分配股利、利润或偿付利息所支付的现金	32	1,261,403.94	39,737,234.55
其中: 子公司支付给少数股东的股利、利润	33	0.00	
支付其他与筹资活动有关的现金	34	144,443.12	
筹资活动现金流出小计	35	75,776,041.24	113,362,110.35
筹资活动产生的现金流量净额	36	-13,594,152.37	-98,370,269.13
四、汇率变动对现金及现金等价物的影响	37	3,059,261.76	
五、现金及现金等价物净增加额	38	-50,161,145.09	-87,734,913.23
加: 期初现金及现金等价物余额	39	82,673,589.47	170,408,502.70
六、期末现金及现金等价物余额	40	32,512,444.38	82,673,589.47

天津正德金林会计师事务所有限责任公司
TIANJIN ZHENGDEJINLIN CERTIFIED PUBLIC ACCOUNTANTS

Audit Report

No.: (2019) 426

To: Peak International Trade (Tianjin) Co., Ltd.

We have audited the accompanying financial statements of Peak International Trade (Tianjin) Co., Ltd. (mentioned below as "your company"), which comprise the balance sheet and the income statement as at December 31, 2018.

1. Management's Responsibility for the Financial Statements

According to the Accounting Standards for Business Enterprises and Accounting Systems for Business Enterprises, preparation of these financial statements is the management's responsibility. This responsibility includes: 1) Designing, implementing and maintaining internal control relevant to the preparation of financial statements that are free from material misstatement, whether due to fraud or error; 2) Selecting and applying appropriate accounting policies; 3) Making reasonable accounting estimates

2. Chartered Accountant's Responsibility



Our responsibility is to express an audit opinion on these financial statements based on our audit. We conducted our audit in accordance with the Auditing Standards of China. These standards require that we comply with ethical requirements and plan and perform the audit to obtain reasonable assurance whether the financial statements are free of material misstatement.

An audit involves performing procedures to obtain audit evidence about the amount and disclosures in the financial statements. The procedures selected depend on the auditor's judgment, including the assessment of the risks of material misstatement of the financial statements, whether due to fraud or error. In making those risk assessments, the auditor considers internal control relevant to the entity's preparation of the financial statements in order to design audit procedures that are appropriate in the circumstances, but not for the purpose of expressing an opinion on the effectiveness of the entity's internal control. An audit also includes evaluating the appropriateness of accounting policies used and reasonableness of accounting estimates made by management, as well as evaluating the overall presentation of the financial statements.

We believe that the audit evidence we have obtained is sufficient and appropriate to provide a basis for our audit opinion.

3. Conclusion of Audit

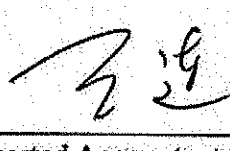
In our opinion, the financial statements present fairly, in all material respects, the financial position of Peak International Trade (Tianjin) Co., Ltd. as of December 31, 2018, and of its financial performance and its cash flows for the year then ended in accordance with the Accounting Standards for Business Enterprises and Accounting Systems for Business Enterprises.

Chartered Accountant: WANG Lianfa
(Signature)



Chartered Accountant: WANG Guiqiu
(Signature)

Date: April 26, 2019

天津正德金林会计师事务所有限责任公司
TIANJIN ZHENGDEJINLIN CERTIFIED PUBLIC ACCOUNTANTS

BALANCE SHEET OF PEAK INTERNATIONAL TRADE (TIANJIN) CO., LTD.					
As of December 31, 2018					
Unit: RMB					
ITEMS	LINE NO.	YEAR-END BALANCE	ITEMS	LINE NO.	YEAR-END BALANCE
CURRENT ASSETS:	1		CURRENT LIABILITIES:	50	
Monetary fund	2	82,673,589.47	Short-term loans	51	7,370,000.00
Short-term investment	3		Notes payable	52	46,779,446.01
Notes receivable	4		Accounts payable	53	51,696,026.00
Dividend receivable	5		Advances from customers	54	38,499,299.06
Interest receivable	6		wages and salaries payable	55	
Accounts receivable	7	70,016,664.96	employee benefits payable	56	
Others receivable	8	86,250,312.04	Dividend payable	57	16,769,507.95
accounts prepaid	9	157,549,841.79	Taxes payable	58	826,256.17
			Miscellaneous payables receivable	59	
Subsidy receivable	10		Other payables	60	47,869,689.15
Inventories	11	14,755,556.63	provision for expenses	61	
unamortised	12		Anticipated liabilities	62	
Long-term debt investments within one year	13		Deferred income	63	
Other current assets	14		Long-term liabilities due within one year	64	
	15		Other current liabilities	65	
	16		TOTAL CURRENT LIABILITIES	66	209,810,224.34
TOTAL CURRENT ASSETS	17	411,245,964.89	LONG-TERM LIABILITIES:	67	
LONG-TERM INVESTMENTS:	18		Long-term loans	68	
Long-term equity interest investments	19		Bonds payable	69	
Long-term debt investments	20		Long-term accounts payable	70	
*consolidation difference	21		Special accounts payable	71	
	22		Other long-term liabilities	72	
	23		Including exchange gains	73	
TOTAL LONG-TERM INVESTMENTS	24	-	TOTAL LONG-TERM LIABILITIES	74	
FIXED ASSETS:	25		DEFERRED TAX:	75	
original cost of fixed assets	26	81,602,503.56	Deferred tax credit	76	
Less: accumulated original depreciation	27	27,942,555.25	TOTAL LIABILITIES	77	209,810,224.34
Fixed assets-net value	28	53,059,948.31	* Minority interest	78	
Less: Fixed assets devalued preparation	29		OWNERS' EQUITY (OR SHAREHOLDERS' EQUITY)	79	
Fixed assets book value	30	53,059,948.31	paid in capital (or share capital)	80	103,929,070.00
Project material	31		Chinese investment amount of non-RMB currency at end of period	81	
Construction in progress	32		Foreign investment amount of non-RMB currency at end of period	82	
Disposal of fixed assets	33		Less investments returned	83	
	34		Paid in capital (or share capital) net value	84	
	35		Capital reserve	85	40,533,444.61
TOTAL FIXED ASSETS	36	53,059,948.31	Surplus reserve	86	26,878,208.58
INTANGIBLE ASSETS AND OTHER ASSETS:	37		Including Public surplus reserve	87	
Intangible assets	38		Public welfare fund	88	
Long-term prepaid expenses	39	14,203,419.52	Voluntary earnings surplus	89	
Other long-term assets	40		Reserve fund	90	
Including exchange loss	41		Enterprise expansion fund	91	
	42		Fund of profit return	92	
	43		to	92	
TOTAL INTANGIBLE ASSETS AND OTHER ASSETS	44	14,203,419.52	Profit this year	93	
DEFERRED TAX:	45		*Uncertain investment loss(*- mark stars for total loss)	94	
Deferred tax debit	46		Undistributed profit	95	97,358,385.19
	47		Currency exchange difference	96	
	48		TOTAL OWNERS' EQUITY (OR SHAREHOLDERS' EQUITY)	97	268,699,108.38
TOTAL ASSETS	49	478,509,332.72	TOTAL ABILITIES AND OWNERS' EQUITY (OR SHAREHOLDERS' EQUITY)	98	478,509,332.72

Note: The items with * are for consolidated financial statements

Chartered Accountant: WANG Lianfa (Signature)

中国注册会计师
王连发

Chartered Accountant: WANG Guiqiu (Signature)

中国注册会计师
王桂秋

天津正德金林会计师事务所有限责任公司
TIANJIN ZHENGDEJINLIN CERTIFIED PUBLIC ACCOUNTANTS

INCOME STATEMENT OF PEAK INTERNATIONAL TRADE (TIANJIN) CO., LTD.
As of December 31, 2018

ITEMS	NO.	Unit: RMB
		THE NUMBER OF THIS YEAR
Main operating revenue	1	2,533,256,177.48
Including: Export sales revenue	2	
Less: Main operating cost	3	2,449,636,765.50
Including: Cost of export sales	4	
Bussiness tax	5	2,356,478.72
Main operating profit ("-" mark stands for loss)	6	81,262,933.26
Add: Income from other operations ("-" mark stands for loss)	7	
Less: Operating expense	8	25,291,071.79
General and administrative expenses	9	29,171,708.51
Financial expense	10	925,156.65
Including: Interest expense (less interest income)	11	
Exchange loss (Less exchange gains)	12	
Operating profit ("-" mark stands for loss)	13	25,874,996.31
Add: Investment income ("-" mark stands for loss)	14	
Subsidy income	15	
Non-operating income	16	
Less: Non-operating expense	17	
Total profit ("-" mark stands for total loss)	18	25,874,996.31
Less: porfit tax	19	6,468,749.08
*Minority shareholders' equity	20	
*Add: uncertain invest-ment loss (filled with "+")	21	
Net profit ("-" mark stands for net loss)	22	19,406,247.23

Note: The items with * are for consolidated financial statements

Supplemental material

ITEMS	THE NUMBER OF THIS YEAR
Proceeds gained by sales handling departement and investment unit	
Natural disaster loss	
Total profit (or loss) from accounting policy change	
Total profit (or loss) from accounting estimate change	
Liabilities reorganization loss	
Others	

Chartered Accountant: WANG Lianfa (Signature)



Chartered Accountant: WANG Guiqiu (Signature)



天津正德金林会计师事务所有限责任公司
TIANJIN ZHENGDEJINLIN CERTIFIED PUBLIC ACCOUNTANTS

Audit Report

No.: (2018) 028

To: Peak International Trade (Tianjin) Co., Ltd.

We have audited the accompanying financial statements of Peak International Trade (Tianjin) Co., Ltd. (mentioned below as "your company"), which comprise the balance sheet and the income statement as at December 31, 2017.

1. Management's Responsibility for the Financial Statements

According to the Accounting Standards for Business Enterprises and Accounting Systems for Business Enterprises, preparation of these financial statements is the management's responsibility. This responsibility includes: 1) Designing, implementing and maintaining internal control relevant to the preparation of financial statements that are free from material misstatement, whether due to fraud or error; 2) Selecting and applying appropriate accounting policies; 3) Making reasonable accounting estimates

2. Chartered Accountant's Responsibility

Our responsibility is to express an audit opinion on these financial statements based on our audit. We conducted our audit in accordance with the Auditing Standards of China. These standards require that we comply with ethical requirements and plan and perform the audit to obtain reasonable assurance whether the financial statements are free of material misstatement. An audit involves performing procedures to obtain audit evidence about the amount and disclosures in the financial statements. The procedures selected depend on the auditor's judgment, including the assessment of the risks of material misstatement of the financial statements, whether due to fraud or error. In making those risk assessments, the auditor considers internal control relevant to the entity's preparation of the financial statements in order to design audit procedures that are appropriate in the circumstances, but not for the purpose of expressing an opinion on the effectiveness of the entity's internal control. An audit also includes evaluating the appropriateness of accounting policies used and reasonableness of accounting estimates made by management, as well as evaluating the overall presentation of the financial statements.

We believe that the audit evidence we have obtained is sufficient and appropriate to provide a basis for our audit opinion.

3. Conclusion of Audit

In our opinion, the financial statements present fairly, in all material respects, the financial position of Peak International Trade (Tianjin) Co., Ltd. as of December 31, 2016, and of its financial performance and its cash flows for the year then ended in accordance with the Accounting Standards for Business Enterprises and Accounting Systems for Business Enterprises.

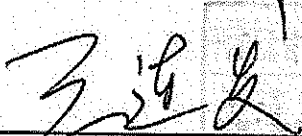

Chartered Accountant: WANG Lianfa
(Signature)



Chartered Accountant: WANG Guiqiu
(Signature)

Date: April 18, 2018

天津正德金林会计师事务所有限责任公司
TIANJIN ZHENGDEJINLIN CERTIFIED PUBLIC ACCOUNTANTS

BALANCE SHEET OF PEAK INTERNATIONAL TRADE (TIANJIN) CO., LTD.
 As of December 31, 2017

No.: (2018) 028
 Unit: RMB

ITEMS	LINE NO.	YEAR-END BALANCE	ITEMS	LINE NO.	YEAR-END BALANCE
CURRENT ASSETS:	1		CURRENT LIABILITIES:	50	
Monetary fund	2	134,293,955.21	Short-term loans	51	116,310,000.00
Short-term investment	3		Notes payable	52	56,660,746.78
Notes receivable	4		Accounts payable	53	103,346,230.69
Dividend receivable	5		Advances from customers	54	29,009,360.93
Interest receivable	6		wages and salaries payable	55	
Accounts receivable	7	128,037,589.10	employee benefits payable	56	
Others receivable	8	78,288,297.74	Dividend payable	57	20,000,000.00
accounts prepaid	9	151,833,589.55	Taxes payable	58	-6,112,415.96
Subsidy receivable	10		Miscellaneous payables	59	
Inventories	11	37,308,202.47	receivable	59	
unamortised	12		Other payables	60	39,462,426.68
Long-term debt investments within one year	13		provision for expenses	61	
Other current assets	14		Anticipated liabilities	62	
	15		Deferred income	63	
	16		Long-term liabilities due within one year	64	
TOTAL CURRENT ASSETS	17	529,761,634.07	Other current liabilities	65	
LONG-TERM INVESTMENTS:	18		TOTAL CURRENT LIABILITIES	66	358,676,349.12
Long-term equity interest investments	19		LONG-TERM LIABILITIES:	67	
Long-term debt investments	20		Long-term loans	68	
*consolidation difference	21		Bonds payable	69	
	22		Long-term accounts payable	70	
	23		Special accounts payable	71	
TOTAL LONG-TERM INVESTMENTS	24	-	Other long-term liabilities	72	
	25		Including exchange gains	73	
FIXED ASSETS:	25		TOTAL LONG-TERM LIABILITIES	74	
original cost of fixed assets	26	80,944,537.77	DEFERRED TAX:	75	
Less accumulated original depreciation	27	23,943,895.08	Deferred tax credit	76	
Fixed assets-net value	28	57,000,642.69	TOTAL LIABILITIES	77	358,676,349.12
Less: Fixed assets devalued preparation	29		* Minority interest	78	
Fixed assets book value:	30	57,000,642.69	OWNERS' EQUITY (OR SHAREHOLDERS' EQUITY)	79	
Project material	31		paid in capital (or share capital)	80	103,929,070.00
Construction in progress	32		Chinese investment amount of non-RMB currency at end of period	81	
Disposal of fixed assets	33		Foreign investment amount of non-RMB currency at end of period	82	
	34		Less: investments returned	83	
	35		Paid in capital (or share capital) net value	84	
TOTAL FIXED ASSETS	36	57,000,642.69	Capital reserve	85	40,533,444.61
INTANGIBLE ASSETS AND OTHER ASSETS:	37		Surplus reserve	86	24,937,583.86
Intangible assets	38		Including: Public surplus reserve	87	
Long-term prepaid expenses	39	21,206,933.51	Public welfare fund	88	
Other long-term assets	40		Voluntary earnings surplus	89	
Including exchange loss	41		Reserve fund	90	
	42		Enterprise expansion fund	91	
	43		Fund of profit return	92	
TOTAL INTANGIBLE ASSETS AND OTHER ASSETS	44	21,206,933.51	Profit this year	93	
DEFERRED TAX:	45		*Uncertain investment loss(*- mark stands for total loss)	94	
Deferred tax debit	46		Undistributed profit	95	79,892,762.68
	47		Currency exchange difference	96	
	48		TOTAL OWNERSEQUITY (OR SHAREHOLDERS' EQUITY)	97	249,292,861.15
TOTAL ASSETS	49	607,969,210.27	TOTAL ABILITIES AND OWNERS' EQUITY (OR SHAREHOLDERS' EQUITY)	98	607,969,210.27

Chartered Accountant WANG Lianfa (Signature)

Chartered Accountant WANG Guiqiu (Signature)

天津正德金林会计师事务所有限责任公司
TIANJIN ZHENGDEJINLIN CERTIFIED PUBLIC ACCOUNTANTS

INCOME STATEMENT OF PEAK INTERNATIONAL TRADE (TIANJIN) CO., LTD.
As of December 31, 2017

No.: (2018) 028

Unit: RMB

ITEMS	NO.	THE NUMBER OF THIS YEAR
Main operating revenue	1	3,677,906,661.03
Including: Export sales revenue	2	
Less: Main operating cost	3	3,555,944,024.33
Including: Cost of export sales	4	
Bussiness tax	5	1,266,004.97
Main operating profit("-" mark stands for loss)	6	120,696,631.73
Add: Income from other operations ("- mark stands for loss)	7	
Less: Operating expense	8	37,223,048.67
General and administrative expenses	9	26,518,205.28
Financial expense	10	14,921,879.85
Including: Interest expense (less interest income)	11	
Exchange loss (Less exchange gains)	12	
Operating profit ("- mark stands for loss)	13	42,033,497.93
Add: Investment income ("- mark stands for loss)	14	
Subsidy income	15	
Non-operating income	16	
Less: Non-operating expense	17	
Total profit ("- mark stands for total loss)	18	42,033,497.93
Less: porfit tax	19	15,347,128.98
*Minority shareholders' equity	20	
*Add: uncertain invest-ment loss (filled with "+")	21	
Net profit ("- mark stands for net loss)	22	26,686,368.95

Note: The items with * are for consolidated financial statements

Supplemental material

ITEMS	THE NUMBER OF THIS YEAR
Proceeds gained by sales handling departement and investment unit	
Natural disaster loss	
Total profit (or loss) from accounting policy change	
Total profit (or loss) from accounting estimate change	
Liabilities reorganization loss	
Others	

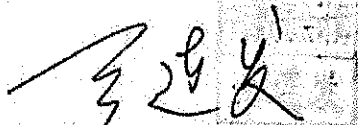
 Chartered Accountant: WANG Lianfa (Signature)

 Chartered Accountant: WANG Guiqiu (Signature)

Summary of Proven Performance with United Nations (System Contracts / LTAs)

Date	Contract No.	Duration	Commodities	Organization	Value (USD)
2007	LTA07/067	4-year	Medical Devices	UNFPA	No limitation
2008	PD/C0019/08	3-year	Transformer and Lamps	UN	2.77M
2008	PD/C0054/08	3-year	Sandbag	UN	1.33M
2008	PD/C0073/08	4-year	Air Conditioning Units	UN	16.7M
2010	UNOPS/2010/ 072	2-year	Motorcycles	UNOPS	No limitation
2010	PD/C0068/10	3-year	Safes	UN	290,000
2010	PD/C0198/10	3-year	Solar Power System and Solar Street Lights	UN	14.1M
2010	PD/C0222/10	4-year	Night Vision Monocular	UN	270,000
2011	PD/C0239/10	6-year	Wastewater Treatment Systems	UN	89M
2011	LTA11/133	4-year	Assembling, Procurement, Warehousing and Distribution Logistics of Emergency Reproductive Health (ERH) Kits	UNFPA	No limitation
2011	PD/C0051/11	5-year	Corrugated Galvanized Iron(CGI) Sheets	UN	9.3M
2011	PD/C0234/11	5-year	Burlap & Polypropylene Sandbags	UN	17M
2012	LTA12/183	3-year	Medical Devices	UNFPA	No limitation
2012	UNOPS/2012/122	5-year	Heavy Trucks and Buses	UNOPS	No limitation
2012	PD/C0229/12	5-year	Air Conditioning Units	UN	35M
2013	FA/2013/PMCS/GOODS/014	3-year	Power Generators (30-600kVA)	UNHCR	No limitation
2013	LTA: 03BPO000024 & 03BPO000025	3-year	Medical Consumables	UNRWA	No limitation
2014	UNOPS/2014/005	3-year	Power Generators (5-700kVA)	UNOPS	No limitation
2014	UNOPS/2014/ 010	3-year	Motorcycles	UNOPS	No limitation
2015	FA/2015/PMCS/GOODS/003	2-year	Razor Wire	UNHCR	No limitation
2015	123083-2-2015	2-year	Waste incinerators	UNOPS	No limitation
2015	LTA15/474	3-year	Medical Devices	UNFPA	No limitation
2015	LTA15/472	3-year	Assembling, Procurement, Warehousing and Distribution Logistics of Emergency Reproductive Health (ERH) Kits	UNFPA	No limitation
2015	PDE/C0041/15	2-year	2-man tents and other accessories	UN	357,503
2015	2015-122281-9	3-year	Construction and Agricultural Machinery	UNOPS	No limitation
2015	2015-123829-12	3-year	Field Motor Vehicles	UNOPS	No limitation
2016	PD/C0217/15	3-year	Airfield Ground Handling Equipment	UN	1.1M
2016	PD/C0006/16	3-year	PV solar systems	UN	23M
2016	PD/C0024/16	3-year	Mobile Crane	UN	1.2M
2016	UNDP/PSU/GP600180-2/6	3-year	Solar water heater	UN DP	500,000

Date	Contract No.	Duration	Commodities	Organization	Value (USD)
2016	PD/C0030/16	3-year	Engineering Equipment	UN	4.1M
2016	PD/C0023/16 & C0024/16	3-year	Material Handling Equipment	UN	3.1M
2016	2016/PSHQ/GDS/0005	2-year	Jerry Can	UNHCR	No limitation
2016	UNOPS-LTA-2016-22-08	3-year	Heavy Trucks, Large Buses and Material Handling Equipment	UNOPS	No limitation
2017	PD/C0016/17	6 months	Modification kits for 20' ISO sea containers for office and accommodation purposes	UNSOS	988,572
2017	No. 3603100	1-year	Provision of Office Furniture	FAO	No limitation
2017	PD/C0064/17	3-year	Provision of General Supplies	UN	No limitation
2017	P/AM168/17	18 months	Supply of various capacities of Generators	UNDP	No limitation
2017	UNOPS-ITB/2017/618/01	2-year	Supply of Security Container - Armories	UNOPS	No limitation
2017	UNDP/PSU/GP600537-11	2-year	Solar Power Systems	UNDP	No limitation
2017	LTA42200498	3-year	Solar Power Systems	UNICEF	No limitation
2017	UNOPS-ITB/2017/618/01	2-year	Security Container - Armories	UNOPS	No limitation
2017	UNOPS/LTA/ITB/2017/616-4	2-year	Energy Efficient Solar Appliances	UNOPS	No limitation
2018	UNFPA/DNK/LTA/18/661	3-year	Medical Devices and Pharmaceuticals	UNFPA	No limitation
2018	LTA42200506	3-year	Motorcycles	UNICEF	No limitation
2018	FA 2018/PSHQ/GDS/0004	3-year	Generating Sets	UNHCR	No limitation

**Past Performance History
(Reference for 2019)**

No.	Business Type	Project Description	Amount (RMB)	Country
1	Direct export	Containerized house	77837.51	Australia
2	Direct export	Containerized house	85003.80	Australia
3	Direct export	Containerized house	696.25	Australia
4	Direct export	Containerized house	14,145.20	Australia
5	Direct export	Containerized Department	1305976.00	Australia
6	Direct export	Containerized Department	1,142,391.80	Australia
7	Direct export	Containerized Department-2nd phase	191,797.34	USA
8	Direct export	Containerized Department	610,769.93	Canada
9	Direct export	Containerized Department	132,948.28	Canada
10	Direct export	Containerized Department-2nd phase	4308.49	USA
11	Direct export	Containerized Department-2nd phase	66,063.56	USA
12	Direct export	Containerized Department-2nd phase	4,798.08	USA
13	Direct export	Containerized Department-2nd phase	3,838.61	USA
14	Direct export	Containerized Department-2nd phase	43,662.62	USA
15	Direct export	Containerized Department	3,065.87	Canada
16	Direct export	CSA containerized office	96,824.34	Canada
17	Direct export	LNGC Canada project	189,306.48	Canada
18	Direct export	LNGC Canada project	185,347.92	Canada
19	Direct export	LNGC Canada project	1,831.36	Canada
20	Direct export	Side door Containerised house	375,653.60	Philippine
21	Direct export	Container for CAT generator	375,142.64	USA
22	Direct export	Container for CAT generator	226,067.34	USA
23	Direct export	Worker house	482,345.40	Papua New Guinea
24	Direct export	LG control container	59,128.32	USA
25	Direct export	Singapore hospital	1,558,083.51	Singapore
26	Direct export	Singapore hospital	1,002,123.76	Singapore
27	Direct export	Singapore hospital	4,116,088.40	Singapore
28	Direct export	Singapore hospital	339,917.44	Singapore
29	Direct export	Container house	177,871.27	Singapore
30	Direct export	Containerized store	803,451.37	North America
31	Direct export	Department	739,588.50	New Caledonia
32	Direct export	Lucy project	4,656,974.00	New Caledonia
33	Direct export	Senegal Camp house	1,576,576.66	Senegal
34	Direct export	Senegal Camp house	64,779.12	Senegal
35	Direct export	FL 45 container	3,909.40	USA
36	Direct export	FL 20 energy storage house	1,291.86	USA
37	Direct export	30 units container house	19,990.00	Norway
38	Direct export	Container house	252,544.00	Norway
39	Direct export	Norway container house	229,354.51	Norway
40	Direct export	Testing for camp flooring	13,136.00	Norway
41	Direct export	Japan touring container	221,561.76	Japan
42	Direct export	Container house	126,983.80	Japan
43	Direct export	Container house	19,923.08	Japan
44	Direct export	Container house	58,298.10	Australia
45	Direct export	Extra wide house	1,925,908.93	Australia
46	Direct export	Side door Containerised house	219,763.44	Italy
47	Direct export	Containerized house with ladders	805,534.68	Canada
48	Direct export	Container	222,235.20	Canada
49	Direct export	Containerized house	306,627.43	Canada
50	Direct export	Containerized house	10,340.70	Canada
51	Direct export	Containerized house	606.65	Canada
52	Direct export	Containerized house	3,970.83	Canada
53	Direct export	Containerized house	310,221.00	Canada

1994 VPS
EVA

54	Direct export	Seychelles house	1501861.96	Seychelles
55	Direct export	Indonesia Housing Placement	20551.58	Indonesia
56	Direct export	Indonesia Housing Placement	12775.30	Indonesia
57	Direct export	Special container house	117174.75	USA
58	Direct export	Special container house	5825.26	USA
59	Direct export	Housing placement	12121.92	Indonesia
60	Direct export	Housing placement	1914550.94	Indonesia
61	Direct export	Housing placement	127887.87	Ireland

Reference Projects in China for Covid-19							
Our design Institute							
Project type	No.	Project Name	Summary	Area	Beds No.	Remarks	Effect date
Reform	1	Reform of fever clinic in TCM Research Institute	697 m ² reconstruction of fever clinic with existing Bungalows	697 m ²	22 beds		28 th Jan, 2020
	2	Transformation of Jinghai ruiansen protective clothing production plant	Jinghai Construction Committee organized 3000 square meters of plant renovation	3000 m ²			31 st Jan, 2020
	3	Reconstruction of fever clinic and observation ward in North Hospital of cancer hospital and increase of CT	Reconstruction of existing organic electricity building (10 beds)		14 Beds	CT, DR	1 st Feb, 2020
	4	Jinghai, Tianjin, China laboratory project	The research and development projects of the Institute of Hematology are 4000 square meters, and the current situation is adding floors and building. Elevation scheme involved	4000 m ²			11 st Feb, 2020
	5	Isolation ward of Academia Sinica		1800 m ²	72 beds		17 th Feb, 2020
	6	Purification plant of Beijing Railway Administration	Mask production plant	750 m ²			21 st Feb, 2020
	Total			10247 m ²			

New Construction	1	Fever clinic and isolation observation ward in children's Hospital	1264 m ²	1264 m ²	20 beds		28 th Jan, 2020
	2	Fever clinic and observation ward of Taishan hospital	Newly built fever clinic and observation ward (30 beds)	1500 m ²	30 beds	CT	1 st Feb, 2020
	3	Fever clinic and isolation observation ward of the fourth hospital	New fever clinic and observation ward (20 beds)	837 m ²	20 beds		3 rd Feb, 2020
	4	Fever clinic and isolation observation ward of the first Central Hospital	New fever clinic and observation ward (20 beds)	1200 m ²	20 beds		31 st Jan, 2020
	5	Fever clinic and isolation observation ward of xianshuigu hospital	1297 M2 newly built fever clinic and observation ward (20 beds)	1297 m ²	20 beds	DR	4 th Feb, 2020
	6	Fever clinic and isolation observation ward and CT in Huanghe hospital	New fever clinic and single channel observation ward (20 beds) in parking lot of Huanghe hospital	800 m ²	20 beds	CT	4 th Feb, 2020
	7	Pre diagnosis and identification Department of central maternity hospital	A new temporary container building will be built in Sanmalu hospital.	800 m ²	10 beds		8 th Feb, 2020
Total			7698 m ²				

Hospital projects for these years

Project type	No.	Project name	Area	Beds	Project period
Already finished projects	1	Reconstruction and expansion project of Tianjin Children's Hospital	76000m ²	530 Beds	2015
	2	Tianjin Airport Hospital	84000 m ²	1200 Beds	2015
	3	Tianjin Binhai cancer hospital phase I	100000 m ²	600 Beds	2016
	4	Qinhuangdao Funing District People's Hospital	70000 m ²	700 Beds	2020
	5	Xi'an Ninth Hospital	139852 m ²	1000 Beds	2020
	6	Tianjin First Central Hospital	380000m ²	2000 beds	2015